



TRACTIVA

by



VERIGA®

SINCE 1922



Kazalo - General index - Inhaltsverzeichnis



www.veriga-lesce.com

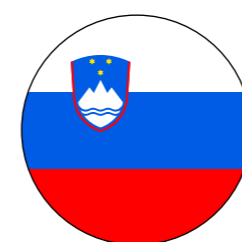

SLOVENSKI KATALOG

4

25



ENGLISH CATALOGUE

26

47



DEUTSCHER KATALOG

48

69



VERIGAsnow

VERIGAsnow pokriva vse snežne kolesne verige za profesionalno in občasno uporabo – od osebnih, terenskih in dostavnih vozil, avtobusov, kamionov, traktorjev do vseh ostalih delovnih strojev. Naše snežne kolesne verige so tista dodatna oprema, ki vam zagotavlja še večji oprijem in varnejšo vožnjo na zasneženih in poledenelih površinah. Smo eden izmed vodilnih svetovnih proizvajalcev snežnih verig, ki se lahko pohvali z dolgoletno tradicijo, kakovostno izdelavo in dolgo življenjsko dobo produktov.

NordicLINE

Linija izdelkov, ki je bila razvita za države, kjer je dovoljena uporaba »ozobljenih« verig na cestah. CAM sistem zaklepanja omogoča hitro in enostavno montažo.

PremiumLINE

Linija izdelkov, ki z najkakovostnejšimi materiali, razvitim proizvodnim procesom in inovativno konstrukcijo zagotavlja izredno kakovost in dolgo življenjsko dobo izdelka.

VERIGAtpc

VERIGAtpc je program zaščitnih kolesnih verig, namenjen težkim delovnim strojem v rudnikih, kamnolomih in smetiščih, kjer glavno namembnost verig predstavlja zaščita pnevmatike. Ta tržna niša nam predstavlja vedno večji prodajni delež, potencialni kupci pa so prisotni po vsem svetu (Evropa, Južna in Severna Amerika, Azija, Avstralija ...).

UPORABA SNEŽNIH VERIG V EVROPI

- Snežne verige so obvezen del zimske opreme.
- Obvezna uporaba snežnih verig v zimskih voznih razmerah.

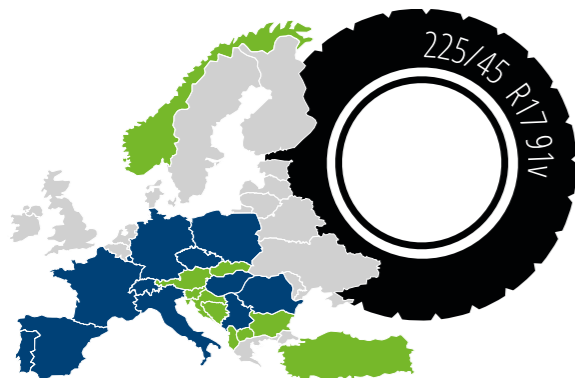

Samo v Evropi gozd pokriva približno 40 % površine, gledano iz svetovnega vidika, znaša pokritost talnih površin z gozdom 31 %. V ta namen smo razvili širok nabor izdelkov, namenjenih splošni in profesionalni uporabi v gozdarstvu. Gozdarstvo predstavlja velik potencial, segment ni tako sezonsko naraven kot snežni program, saj se izvaja večino leta. VERIGAforest program je razdeljen na linijo GreenTRACK, katero predstavljajo gosenice za delovne stroje, linijo kolesnih verige za traktorje in delovne stroje ter linijo vlečnih verig in gozdarskih elementov, namenjenih spravilu lesa. Izdelke programa VERIGAforest, odlikuje visokokakovostna izdelava in obdelava, kar izdelkom omogoča dolgo življenjsko dobo.



Linija gosenic GreenTRACK za gozdarske stroje je bila razvita z namenom povečanja oprijema na različnih tipih podlage in boljše zaščite pnevmatik. Posebnost izdelkov linije GreenTRACK je v svojevrstnem postopku termične obdelave, ki zagotavlja enakomerno trdoto tudi na varjenih spojih.



Športni program je skrbno premišljen dodatni program, razvit pod budnim očesom naših strokovnih sodelavcev. Bili smo prvi, ki smo svetu predstavili dereze za prosti čas. Zaradi izjemno pozitivnih povratnih informacij, s strani naših zadovoljnih uporabnikov, smo pričeli vse več virov in marketinških aktivnosti usmerjati v prepoznavnost blagovne znamke VERIGAsport s končnim ciljem ter željo: približati se našim končnim uporabnikom.

POMOČNIK PRI IZBIRI VERIG ZA OSEBNO VOZILO

Kaj pomenijo oznake na pnevmatiki?

Oznake boste našli na boku pnevmatik, ki so že nameščene na vašem vozilu. Primer oznake si lahko ogledate tudi na ilustraciji. Oznaka **225/45 R 17 91V** torej pomeni:

- 225:** širina pnevmatike v mm
- 45:** presek pnevmatike v % (razmerje med višino in širino pnevmatike)
- R:** konstrukcijska izvedba pnevmatike – RADIJALNA
- 17:** premer platišča v palcih
- 91:** indeks nosilnosti
- V:** indeks hitrosti

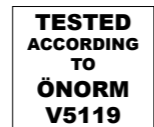

VERIGA: ZGODOVINA

6



TRACTIVA: KONCEPT



8

TRACTIVA: TEHNOLOGIJA

10

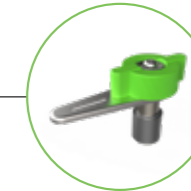

TRACTIVA: MODELI



12

TRACTIVA AVTO

13



TRACTIVA SPORT

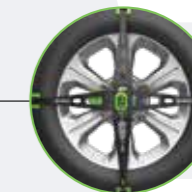

14

TRACTIVA SUV

15



TRACTIVA REZERVNI DELI

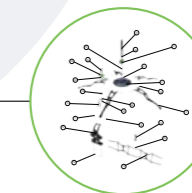

16

TRACTIVA DIMENZIJSKI PROGRAM

20

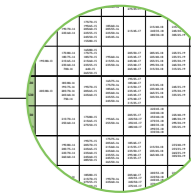

TRACTIVA VAN

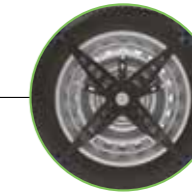

22

TRACTIVA CARGO

24

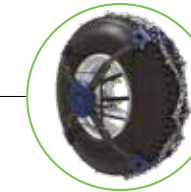

TRACTIVA PRO



25

ZGODOVINA VERIGA LESCE

Tovarna Veriga je bila ustanovljena daljnega leta 1922. Podjetje je skozi različna zgodovinska obdobja izdelovalo številne izdelke, med katerimi so prvotno prevladovali vijaki, odkovki, težke sidrne verige, gozdarske vlečne verige, transportne verige za rudarstvo ter raznovrstne metrske verige od debeline 1 mm do 100 mm. Kasneje se je proizvodnja razširila tudi na zaščitne verige za traktorje in delovne stroje ter snežne verige za avtomobile. Leta 1992 je bila proizvedena, patentirana in certificirana veriga RIVAL COMPACT, predhodnica današnjih avtomobilskih verig.

Dobro planiran proizvodni program in prvovrstna kakovost izdelkov je Verigo uvrščal med večje proizvajalce na evropskem in svetovnem trgu, zaradi česar so se verige izdelovale tudi za mnoge svetovno znane proizvajalce verig. V teh časih je Veriga zaposlovala več kot 1.500 delavcev. Leta 1998 se je podjetje lastniško preoblikovalo in preimenovalo v VERIGA K.F., d.o.o.

PROIZVODNI PROGRAM OBSEGA:

- Snežne verige za avtomobile, lahka dostavna vozila, 4 x 4, kamione, traktorje in delovne stroje
- Gozdarske verige za traktorje in delovne stroje za vleko lesa
- Gosenice za gozdarske stroje in pogonske prikolice
- Zaščitne verige za delovne stroje
- Pohodne dereze za čevlje in športni program

Danes so naši izdelki prisotni tako na domačem, predvsem pa na svetovnem trgu. Veriga z leti vedno bolj uspešno konkurira največjim svetovnim proizvajalcem verig in je vedno bolj prepoznavna pod svojo blagovno znamko VERIGA.

SINCE 1922



TRACTIVA

TRACTIVA: evolucija snežne verige.

V sodelovanju z nekdanjim razvijalcem in oblikovalcem verige Trak vam predstavljamo evolucijo klasične snežne verige – Veriga Tractiva. Močnejša, preprostejša, odpornejša in učinkovitejša – Veriga Tractiva združuje številne izkušnje, ure raziskav, testiranj, izboljšav in popravkov, ki so bili potrebni za razvoj najzanesljivejše verige doslej, ki je hkrati enostavna za uporabo.

1. SAMODEJNA MONTAŽA – učinek vzmeti

Skrivnost hitre samozatezne montaže je v jeklenih rokah, kaljenih po posebnem postopku, ki s svojim vzmetnim učinkom pričvrstijo verigo na kolo tudi v najbolj neizprosni pogojih.



2. BREZ POSEGANJA V KOLOTEK – za vse vrste avtomobilov

Veriga Tractiva je izvrstna izbira za večino sodobnih avtomobilov. Ker ne sega na notranjo stran kolesa, je primerna tudi za vozila, na katera ni mogoče namestiti klasičnih verig, saj bi ta lahko ovirala delovanje prenosa ali zavor.



3. BOLJŠI OPRIJEM – na snegu in ledu

S pomočjo posebnih poliuretanskih vodil in bodic iz volframo-vega karbida ima Veriga Tractiva izjemen oprijem na spolzkih površinah. Dodaten oprijem v najzahtevnejših razmerah zagotavljajo posebni kvadratno oblikovani odseki verige s prečno postavljenimi kovinskimi profili.

4. SAMODEJNO ZATEZANJE – primerno za vse pnevmatike

Posebni gumijasti zatezni elementi na Tractivi omogočajo uporabo in prileganje verige tako na novih kot tudi na že obrabljenih pnevmatikah, pametna samozatezna funkcija pa poskrbi za popolno pričvrstitev.



5. CELOSTNA PONUDBA – za vsa osebna vozila

Zaradi pametne zasnove in domišljene proizvodnje ne bo več napak pri iskanju pravih dimenzij za vaše vozilo, saj relativno majhno število produktov pokriva več kot 90 % pnevmatik na trgu. Poleg tega pa obstaja velika verjetnost, da bo en komplet verig Tractiva ustrezal več vozilom oz. da v primeru menjave vozila ne bo treba menjati tudi verig. Celoten spekter osebnih vozil je pokrit z le 13 dimenzijami, od tega 6 za SUV in športna vozila ter 7 za ostala.

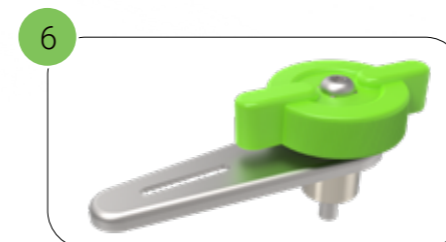

6. HITRA MONTAŽA – sistem pritrditve Tractiva

Brez vnaprejšnjega nameščanja posebnih vijakov ali nastavkov, brez posebnega orodja za zategovanje verige; vse kar potrebujete za pričvrstitev verige na kolesni vijak, so vaše roke. Za celoten sistem je potrebnih manj sestavnih delov, kar hkrati pomeni tudi optimizirano proizvodnjo, manj porabljenih surovin in manj onesnaževanja okolja.

TRACTIVA

TRACTIVA TECH:
tehnologija in rešitve za varno vožnjo pozimi.



1. SISTEM PRITRJEVANJA TRACTIVA

Dvostopenjski sistem pritrjevanja najprej pretvori krožno gibanje v stisk kolesnega vijaka, nato pa naprednejši sistem izkorišča učinek vzvoda za še močnejšo in varnejšo pričvrstitev.



2. INOVATIVEN PATENTIRAN MEHANIZEM "CLE"

Poseben mehanizem omogoča hitro montažo in demontažo, s pomočjo vzvoda. Le-ta brez dodatnega orodja zagotavlja čvrsto in zanesljivo pritrnitev na kolesni vijak.



3. TEHNOLOGIJA VPETJA

Zanesljivost našega sistema temelji na posebej skonstruiranih oprijemalnih z utori, ki se prilegajo 95 % avtomobilom na trgu.

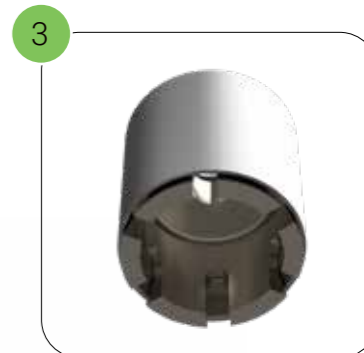

4. PAMETNA OPRIJEMALA

Izredno natančno smo preučili, kakšna morata biti kota β in γ , da se oprijemalo ujame z večino oblik kolesnih vijakov.

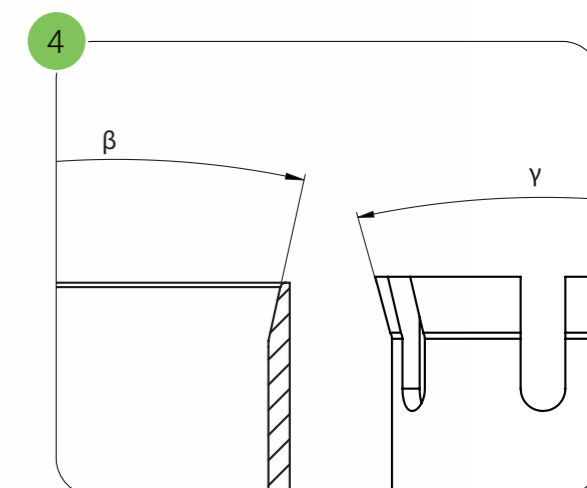

5. ENOTOČKOVNA PRITRDITEV

Veriga se pritrdi na kolo z vpetjem na le en kolesni vijak, brez potrebe po kakršnihkoli drugih nastavkih. Dodana distančnika omogočata prilagoditev in montažo tudi na zelo ploska ali globoka platišča.



MODELI PREGLED



KODA	A09 - A17	S11 - S17	U49 - U55	V10-V110	TC-T6-T29	TP-T20-T29
MODEL	TRACTIVA AUTO	TRACTIVA SPORT	TRACTIVA SUV	TRACTIVA VAN	TRACTIVA CARGO	TRACTIVA PRO
PRIPOROCAMO ZA						
ODMIK PO STANDARDU EN 16662-1	0/16	0/12	0/16	0/16	0/22	0/22
MAKSIMALEN ODMIK OD NOTRANJEGA ROBA PNEVMATIKE	0	0	0	0	0	0
MAKSIMALEN ODMIK OD POVRŠINE PNEVMATIKE	16	12	16	16	22	22
SAMODEJNO ZATEZANJE	✓	✓	✓	✓	✓	✓
SAMODEJNA MONTAŽA	✓	✓	✓	✓	✓	✓
PREPROSTOST MONTAŽE	10 ★★★★★★	10 ★★★★★★	10 ★★★★★★	10 ★★★★★★	10 ★★★★★★	10 ★★★★★★
RAVEN OPRIJEMA	10 ★★★★★★	9 ★★★★★★	9 ★★★★★★	9 ★★★★★★	10 ★★★★★★	10 ★★★★★★
UDOBJE V VOŽNJI	9 ★★★★★★	10 ★★★★★★	9 ★★★★★★	9 ★★★★★★	9 ★★★★★★	10 ★★★★★★

TRACTIVA AUTO



S 16-mm višino člena je Tractiva Auto najmočnejša in najbolj trpežna veriga znotraj linije Tractiva.

- Homologirana po standardu EN 16662-1 in ONV5117.
- Inovativna mrežna konstrukcija tekalnega dela.
- Cementirani verižni deli z gumijastimi zateznimi elementi in posebnimi prečnimi profili za boljši oprijem.
- Poliuretanska vodila s karbidnimi bodicami.
- Pametni sistem pritrdjevanja Tractiva.
- Komplet vijakov in navodila za uporabo.
- Najlonska torba in kartonasta embalaža.

MERE

	D [mm]	4
	H [mm]	16

EMBALAŽA



TRACTIVA SPORT



Z le 10-mm višino člena je Tractiva Sport najlažja in najkompaktnejša veriga znotraj linije Tractiva.

- Homologirana po standardu EN 16662-1 in ONV5117.
- Inovativna mrežna konstrukcija tekalnega dela.
- Cementirani verižni deli z gumijastimi zateznimi elementi in posebnimi prečnimi profili za boljši oprijem.
- Poliuretanska vodila s karbidnimi bodicami.
- Pametni sistem pritrjevanja Tractiva.
- Komplet vijakov in navodila za uporabo.
- Najlonska torba in kartonasta embalaža.

MERE

	D [mm]	3
	H [mm]	10

EMBALAŽA



TRACTIVA SUV



Tractiva SUV je s 16-mm višino člena narejena za najbolj ekstremne razmere. Členi v D-profilu pa bodo vašemu SUV-ju dali dodaten oprijem, da bo še lažje zagrizel v sneženo oz. ledeno podlago.

- Homologirana po standardu EN 16662-1 in ONV5117.
- Inovativna mrežna konstrukcija tekalnega dela.
- Cementirani verižni deli z gumijastimi zateznimi elementi in posebnimi prečnimi profili za boljši oprijem.
- Poliuretanska vodila s karbidnimi bodicami.
- Pametni sistem pritrjevanja Tractiva.
- Komplet vijakov in navodila za uporabo.
- Najlonska torba in kartonasta embalaža.

MERE

	D [mm]	4
	H [mm]	16

EMBALAŽA





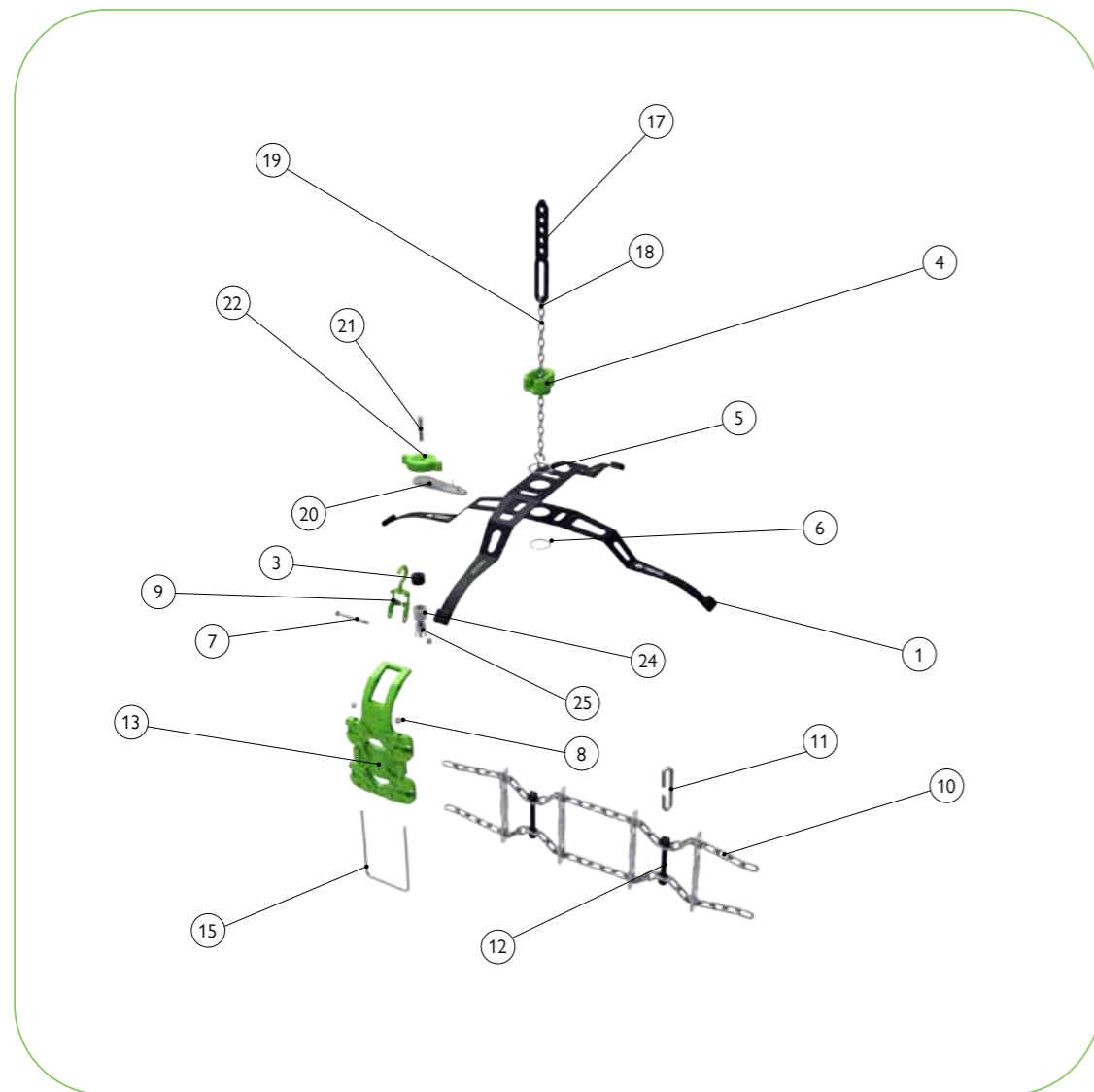







AUTO, SPORT & SUV



rezervni deli	kode	opis	rezervni deli	kode	opis
1	47895 RT-A10 47896 RT-A20 47897 RT-A30 47898 RT-A40 47899 RT-A50 47900 RT-A60 47901 RT-A70	Tractiva kovinska roka za modela Auto in Sport	6	43828 (100 00 003)	Vskočnik za kovinske roke
2	47902 RT-U10 47903 RT-U20 47904 RT-U30 47905 RT-U40 47906 RT-U50 47907 RT-U60	Tractiva kovinska roka za model SUV	7	43829 M5X50	Vijak M5 × 50
3	a. 43846 DDT b. 43847 DKT	a. Distančnik dolgi Tractiva b. Distančnik kratki Tractiva	8	a. 43830 (M5 MATICA) b. 43831 (M3,5 MATICA)	a. Matica M5 b. Matica M3,5
4	43826 ZCT	Zapora centralna Tractiva	9	43832 KNVT	Kavelj za napenjalno verigo Tractiva
5	43827 TPRT	Teflonska podložka za roke	10	43618-43 43873-40 43871-42 43874-39 43872-41 43875-38	Verižni segment za: a. model Sport
				43619-32 43880-28 43877-31 43881-27 43878-30 43882-26 43879-29	Verižni segment za: b. modela Auto in SUV

REZERVNI DELI POVZETEK

rezervni deli	kode	opis
11 	43834 CST	Člen skrajševalni Tractiva
12 a.  b. 	a. 43835 GTS b. 43836 GTAS	a. Guma Tractiva Sport b. Guma Tractiva Auto/SUV
13 a.  b. 	a. 43837 EVTAS b. 43838 EVTS	a. Element vodilni Tractiva Auto in SUV b. Element vodilni Tractiva Sport
14 a.  b. 	a. 26982 b. 43885	a. Zatik vzmetni 6 x 30 mm b. Povezovalni zatič za verižni člen
15 	43886	Okvir za model Sport

rezervni deli	kode	opis
16 	43857 SNT	Sistem napenjalni Tractiva
17 	43839 GNT	Guma napenjalna Tractiva
18 	43840 COT	Člen odprti Tractiva
19 	43841 VNT	Veriga napenjalna Tractiva
20 	43842 PCT	Plošča centralna Tractiva

REZERVNI DELI POVZETEK

rezervni deli	kode	opis
21 a.  b. 	a. 43843 M8x60 b. 43844 M8x95	a. Vijak M8 x 60 b. Vijak M8 x 95
22 	43845 KMT	Kolo montažno Tractiva
23 	a. 43848 O-17-T b. 43849 O-19-T c. 43850 O-21-T d. 44208 O-22-T	a. Ohišje 17 mm Tractiva b. Ohišje 19 mm Tractiva c. Ohišje 21 mm Tractiva d. Ohišje 22 mm Tractiva

rezervni deli	kode	opis
24 	a. 43851 D-17-T b. 43852 D-19-T c. 43853 D-21-T d. 44209 D-22-T	a. Držalo 17 mm Tractiva b. Držalo 19 mm Tractiva c. Držalo 21 mm Tractiva d. Držalo 22 mm Tractiva
25 	a. 43854 V-17-T b. 43855 V-19-T c. 43856 V-21-T d. 44210 V-22-T	a. Vtikač 17 mm Tractiva b. Vtikač 19 mm Tractiva c. Vtikač 21 mm Tractiva d. Vtikač 22 mm Tractiva
26 	49126	Vtikač Tractiva univerzalni

Barve se lahko razlikujejo glede na izbrani izdelek.

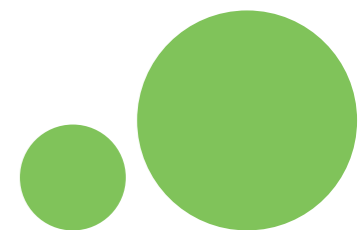

TRACTIVA AUTO & SPORT

DIMENZIJSKI PROGRAM

številka verige	13' - 14'	15'	16'	17'	18'	19'	20'	21' - 24'	
AUTO TA 10 SPORT TS 10	175/80-13 S1 235/60-13 S1 255/55-13 S1 165/80-14 S4 175/75-14 S3 185/70-14 S2 195/65-14 S1 205/65-14 S4 215/60-14 S2	165/70-15 S1 175/65-15 S1 185/60-15 185/55-16 S1 195/55-16 S4 205/50-16 S1 205/55-15 215/55-15 S3 215/45-16 225/50-15 235/50-15 S2 255/45-15 S1 265/45-15 S4 285/40-15 S1 345/35-15 S4	175/60-16 S2 185/55-16 S1 195/55-16 S4 205/50-16 S1 215/45-16 225/40-17 235/40-17 S4 245/35-17 255/45-16 S1 265/45-16 S3 255/40-16 S1 265/40-16 S3	175/55-17 S4 185/50-17 S3 195/45-17 205/45-17 S2 215/40-17 225/40-17 S1 235/40-17 S4 245/35-17 255/35-18 S4 245/30-18 255/30-18 S1 265/30-18 S2 275/35-17 S4	205/40-18 S4 215/35-18 225/35-18 S2 235/35-18 S4 245/30-18 255/30-18 S1 265/30-18 S2	225/30-19 S3 235/30-19 S4	275/20-20 S3		
AUTO TA20 SPORT TS20	185/80-13 195/80-13 S4 165/80-14 S4 175/75-14 S3 185/70-14 S2 195/65-14 S1 215/65-14 S2 225/60-14 235/60-14 S2	155/80-15 185/70-15 S3 195/65-15 S2 205/60-15 215/60-15 S3 225/55-15 235/55-15 S3 245/50-15 265/50-15 S4 275/45-15	185/60-16 205/55-16 S1 225/50-16 S1 235/50-16 S3 245/45-16 255/45-16 S2 275/40-16	205/50-17 S2 215/45-17 225/45-17 S1 245/40-17 255/40-17 S2 285/30-18 295/30-18 S1	205/45-18 S4 215/40-18 225/40-18 S2 245/35-18 255/35-18 S2 285/30-18 295/30-18 S1	215/35-19 S1 225/35-19 S3 245/30-19 255/30-19 S2 265/30-19 S4 305/25-19 S2 315/25-19 S3	225/30-20 S4 275/25-20 S4		
AUTO TA30	195/75-13	165/80-15 175/75-15 175/80-15 S4 185/75-15 S4 205/65-15 S1 215/55-16 215/65-15 S4 225/60-15 S2 270/50-15 S2 275/50-15 S3	165/75-16 S3 175/70-16 S2 185/65-16 S1 195/60-16 205/60-16 S2 215/55-16 225/55-16 S3 245/50-16 S2 250/50-16 S3 255/50-16 S4	175/65-17 S4 185/60-17 S3 195/55-17 205/55-17 S3 215/50-17 S1 225/50-17 S3 235/45-17 245/45-17 S2 255/45-17 S4 265/40-17 275/40-17 S2 285/40-17 S4 315/35-17 S2	175/55-18 S2 195/50-18 S2 215/45-18 S2 225/45-18 S4 235/40-18 245/40-18 S2 255/40-18 S4 265/35-18 275/35-18 S2 285/35-18 S3 315/30-18 325/30-18 S2 335/30-18 S4	235/35-19 S1 245/35-19 S3 275/30-19 S1 285/30-19 S3 295/30-19 S4 335/25-19 S2 355/25-19 S4	235/30-20 S1 245/30-20 S3 255/30-20 S4 285/25-20 S2 295/25-20 S3		
AUTO TA40 SPORT TS40	195/80-14 S2 265/60-14 S4	195/70-15 195/75-15 S4 225/65-15 S4 235/60-15 S1 245/60-15 S4 285/50-15 S2	175/75-16 195/65-16 215/60-16 S1 220/60-16 S3 225/60-16 S4 235/55-16 S2 245/55-16 S2 265/50-16 S3	185/65-17 S3 195/60-17 S2 215/55-17 S2 235/50-17 S2 265/45-17 S3 295/40-17 S2 335/35-17 S2	195/55-18 S3 205/50-18 S1 215/50-18 S3 235/45-18 S3 265/40-18 S3 295/35-18 S1	225/40-19 S1 235/40-19 S3 255/35-19 265/35-19 S2 305/30-19 S2 315/30-19 S3	225/35-20 S2 265/30-20 S2 305/25-20 315/25-20 S2 325/25-20 S3	235/30-21 S4 275/25-21 S3	
AUTO TA50 SPORT TS50	205/80-14 S4 215/75-14 S3	185/80-15 S3 205/70-15 275/55-15 S4 295/50-15 S2	195/70-16 S3 205/65-16 S2	205/60-17 S3 225/55-17 S3 245/50-17 S3 275/45-17 S3	205/55-18 S4 225/50-18 S4 245/45-18 S3 275/40-18 S3 315/35-18 S3	195/50-19 S3 245/40-19 S3 275/35-19 S2 285/35-19 S4 325/30-19 S3 335/30-19 S4	225/40-20 S3 235/35-20 S2 245/35-20 S3 275/30-20 S2 285/30-20 S3 335/25-20 S2 345/25-20 S4	245/30-21 S3 295/25-21 S4 375/20-21 S4	
AUTO TA60 SPORT TS60	215/80-14 S1	195/80-15 S4 205/75-15 S3 215/70-15 S2 235/65-15 S3 255/60-15 S3 305/50-15 S2	175/80-16 S2 205/70-16 S4 255/55-16 S3	185/70-17 S4 255/50-17 S3	195/60-18 S4 255/45-18 S3 285/40-18 S2 295/40-18 S4	175/60-19 S4 205/50-19 S3 225/45-19 S2 255/40-19 S3 295/35-19 S3 345/30-19 S4	155/60-20 S4 265/35-20 S4	255/30-21 S2 265/30-21 S4 255/25-22 S2	
AUTO TA70 SPORT TS70		205/80-15 S4 215/75-15 S2 225/70-15 235/70-15 S4 245/65-15 S1 275/60-15 S4	185/75-16 195/75-16 S1 215/65-16 215/70-16 S3 225/65-16 S1 235/60-16 245/60-16 S1 275/55-16 S4 295/50-16 S2	205/65-17 S1 215/60-17 215/65-17 S4 225/60-17 S2 235/55-17 245/55-17 S2 275/50-17 S3	215/55-18 225/55-18 S3 235/50-18 245/50-18 S2 250/50-18 S2 265/45-18 275/45-18 S3 345/35-18 S1	205/55-19 S3 215/50-19 S1 225/50-19 S3 235/45-19 245/45-19 S2 265/40-19 275/40-19 S2 285/40-19 S4 305/35-19 325/35-19 S4	175/55-20 195/50-20 S2 215/45-20 S2 225/45-20 S4 245/40-20 S2 255/40-20 S4 275/35-20 S2 285/35-20 S3 295/30-20 305/30-20 315/30-20 S1 325/30-20 S2 335/30-20 S4	245/35-21 S3 255/35-21 S4 275/30-21 S1 285/30-21 S2 295/30-21 S4 325/25-21 345/25-21 S3 355/25-21 S4 235/30-22 S1 245/30-22 S3 255/30-22 S4 275/25-22 285/25-22 S2 295/25-22 S3 305/25-22 S4	

Na verigi so nameščene 4 skrajšave.

S1-S4 = število skrajšav, ki jih lahko po potrebi odstranite.

TRACTIVA 4x4 SUV & VAN

DIMENZIJSKI PROGRAM

številka verige	14' - 15'	16'	17'	18'	19'	20	21' - 24'	številka verige	14' - 19'
SUV TU10	255/70-14 265/70-14 S4 225/75-15 S2 235/70-15 S4 245/70-15 S3 255/65-15 265/65-15 S4	195/80-16 S2 195/85-16 S4 205/75-16 S1 225/70-16 S2 235/60-16 235/65-16 245/65-16 S4 255/60-16 265/60-16 S3	205/70-17 S2 215/65-17 S4 225/65-17 S3 235/60-17 S1 245/60-17 S4 255/55-17 265/55-17 S3 315/45-17 S1	215/60-18 S1 235/55-18 S1 245/55-18 S4 255/50-18 265/50-18 S3 285/45-18 S1 295/45-18 S3	205/55-19 S3 215/55-19 S2 235/50-19 S2 255/45-19 265/45-19 S2 295/40-19 S2 345/35-19 S3	195/55-20 S3 235/45-20 S2 245/45-20 S4 255/40-20 S4 265/40-20 S2 285/35-20 S3 295/35-20 S1 305/35-20 S3 345/30-20 S1	265/35-21 S2 275/35-21 S4 305/30-21 S1 315/30-21 S3 265/30-22 S2 275/30-22 S3 315/25-22 S1 335/25-22 S4	VAN TV10	175/70-14 185/60-15 195/60-15 S2 195/55-16 S4
SUV TU20	215/80-15 S1 235/75-15 S4	215/75-16 235/70-16 S4 275/60-16 S4	215/70-17 S3 235/65-17 S4 275/55-17 S4	225/60-18 S2 235/60-18 255/55-18 S4 275/50-18 S3	245/50-19 S2 255/50-19 S4 275/45-19 S2 285/45-19	275/40-20 S2 285/40-20 S4 315/35-20 S2 325/35-20 S4	245/40-21 S2 255/40-21 S4 285/35-21 S3 325/30-21 S2 245/35-22 S2 255/35-22 S4 285/30-22 S2 295/30-22 S4 305/25-23 S4	VAN TV20	185/65-15 S4 195/65-15 S2 205/55-16 195/60-16 205/50-17 S2
SUV TU30	225/80-15 S1 255/70-15 265/70-15 S4 275/65-15	205/80-16 205/85-16 S4 215/80-16 S3 225/75-16 S2 225/80-16 S4 245/70-16 S3 255/65-16 265/65-16 S3 285/60-16 S3	195/80-17 S2 205/75-17 245/65-17 S3 255/60-17 265/60-17 S3	225/65-18 S3 245/60-18 S3 265/55-18 S3 285/50-18 S1	225/55-19 S2 235/55-19 S1 245/55-19 S4 265/50-19 S3 295/45-19 S3	235/50-20 S1 245/50-20 S4 295/40-20 S2 305/40-20 S4	195/55-21 S3 235/45-21 S2 245/45-21 S4 265/40-21 S2 295/35-21 S1 315/35-21 S4 345/30-21 S1 265/35-22 S2 275/35-22 S3 305/30-22 S1 315/30-22 S3 275/30-23 S3 315/25-23 S1 275/25-24 S2 285/25-24 S4	VAN TV30	195/70-15 205/60-16 S2 215/55-16 215/50-17 S1
SUV TU40	245/75-15 255/75-15 S4 275/70-15	235/75-16 S3 255/70-16 S4 275/65-16 S4	225/70-17 235/70-17 S3 255/65-17 S4 275/60-17 S4	235/65 18 S4 255/60 18 S4	235/60-19 S4 255/55-19 S4 275/50-19 S2	195/65-20 S4 255/45-20 265/50-20 S4 265/45-20 275/45-20 S2	305/35-21 255/40-22 S4 285/35-22 S2 295/30-23 S3 255/30-24 S4	VAN TV40	215/65-15 S4 195/65-16 215/60-16 S1 205/55-17 S3 215/55-17 S2 225/45-18 S4
SUV TU50	265/75-15 S3 275/75-15 S3 325/60-15 S1	245/75-16 S2 215/85-16 S1 235/80-16 S4 265/70-16 S2 285/65-16 S2	225/75-17 235/75-17 S4 245/70-17 S2 265/65-17 S2 285/60-17 S2	225/70 18 S1 265/60 18 S2 285/55 18 S1	265/55-19 S2 275/55-19 S4 285/50-19	235/55 20 0 265/50 20 S1 285/45 20 295/45 20 S2	235/50-21 255/45-21 S4 265/45-21 S1 275/40-21 S1 285/40-21 265/40-22 S1 295/35-22 305/35-22 S1 315/35-22 S3 275/35-23 S2 285/35-23 S4 305/30-23 315/30-23 S1 325/30-23 S3 275/30-24 S2 285/30-24 S4	VAN TV50	215/70-15 S2 205/65-16 S2 225/55-17 S3 245/45-18 S3
SUV TU60	245/85-15 S4 32X11.5 15	225/85-16 S2 255/75-16 S2 275/70-16 S2 280/70-16 S4	245/75-17 S4 255/70-17 S2 265/70-17 275/65-17 S2	255/65-18 S2 275/60-18 S1 285/60-18 S4	235/65-19 S2 255/60-19 S2 285/55-19 S4	235/60-20 S2 255/55-20 S2 275/50-20 275/55-20 285/50-20 S3 305/45-20	255/50-21 S2 275/45-21 285/45-21 S2 295/40-21 315/40-21 S4 255/45-22 S2 275/40-22 275/45-22 285/40-22 S1 295/40-22 S4 325/35-22 S1 265/40-23 S4 285/40-23 295/35-23 S2 305/35-23 S4 315/30-24 S4	VAN TV60	235/55-17 215/60-17 255/45-18 S3
								VAN TV70	225/70-15 195/75-16 S1 215/65-16 225/65-16 S1 245/45-19 S2
								VAN TV80	205/75-16 S1 235/65-16
								VAN TV90	215/75-16
								VAN TV100	225/75-16 S2
								VAN TV110	255/65-17 S4 255/60-18 S4
								VAN TV120	245/75-16 S2

Na verigi so nameščene 4 skrajšave.

S1-S4 = število skrajšav, ki jih lahko po potrebi odstranite.

TRACTIVA VAN



Veriga s hitro montažo, samodejnim zatezanjem in brez vpenjanja zadaj je prava izbira za vse, ki se boste z avtomodom podali na zimske avanture. Prav bo prišla tudi vsem dostavnim vozilom, saj vam bo s 16 mm D-členi na zasneženih in poledenelih cestah nudila boljši oprijem ter večjo stabilnost.

- Homologirana po standardu EN 16662-1 in ONV5117.
- Inovativna mrežna konstrukcija tekalnega dela.
- Cementirani verižni deli z gumijastimi zateznimi elementi in posebnimi prečnimi profili za boljši oprijem.
- sistem 4 ročic in jeklenih karbonskih konic na 4 poliuretanskih vodilih.
- poseben, patentiran način vpenjanja.

Pakirano: 1 par v najlonski torba in kartonasti embalaži.

MERE

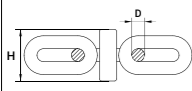
	D [mm]	4
	H [mm]	16

EMBALAŽA



TRACTIVA CARGO



Veriga za tovorna vozila s hitro montažo. Tractiva CARGO je opremljena s členom 6 mm D profila. Nameščena z zunanje strani pnevmatike, s sistemom 4 ročic in jeklenimi karbonskimi konicami na 4 plastičnih vodilih.

- Testirano v skladu z ON V5119.
- Inovativna patentirana rešitev za montažo.
- Kaljena veriga s kovinskimi držali in krajšalnimi vijaki za regulacijo.
- Poliuretanska vodila s karbonskimi konicami.
- Navodila za uporabo omogočajo hitro montažo.

Pakiranje: vsaka polovica para je v torbi iz obstojnega blaga.

MERE

	D [mm]	6
	H [mm]	22

TRACTIVA PRO



Tractiva Pro, opremljena s 6 mm členi D profila in je profesionalna rešitev z največjim oprijemom zahvaljujoč konfiguraciji 6 krakov in konicam karbonskimi na 6 plastičnih vodilih. Primeren za najzahtevnejše voznike, za mednarodne poti, za vse priložnosti, kjer je hitra montaža in demontaža nujna.

- Testirano v skladu z ON V5119.
- Inovativna patentirana rešitev za montažo.
- Kaljena veriga s kovinskimi držali in krajšalnimi vijaki za regulacijo.
- Poliuretanska vodila s karbonskimi konicami.
- Navodila za uporabo omogočajo hitro montažo.

Pakiranje: vsaka polovica para je v torbi iz obstojnega blaga.

MERE

	D [mm]	6
	H [mm]	22



VERIGAsnow

VERIGAsnow comprises tyre chains for professional and occasional use - from cars, off-road and delivery vehicles, buses, trucks, tractors to all other work machines. Our snow tyre chains are the accessories that provide you with even more traction and a safer ride on snowy and icy terrain. We are one of the world's leading manufacturers of snow chains, boasting a long tradition, quality workmanship and long product life.

NordicLINE

A line of products developed for countries in which the use of »toothed« chains is allowed on roads. CAM locking system enables fast and easy assembly.

PremiumLINE

A line of high-quality products with long service life. Thanks to innovative design, strongest material and manufacturing process.

VERIGAtpc

VERIGAtpc is a programme of protective tyre chains intended for heavy working machines in mines, quarries and landfills, where the main purpose of the chains is to protect the tyre. This niche represents an ever-increasing sales share, and potential buyers come from all over the world (Europe, South and North America, Asia, Australia,...).

USE OF CHAINS IN EUROPE

- Legal obligation to carry chains
- Obligation to carry chains in winter conditions

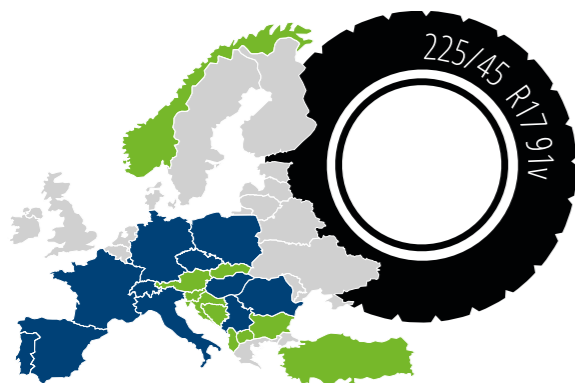

VERIGAforest

Forests cover 31 % of the global landscape, and in Europe alone, that number rises to approximately 40 %. To this end, we have developed a wide range of products intended for general and professional use in forestry. With forestry being practically a year-round occupation and not as seasonal as the snow programme, it represents great potential. The VERIGAforest programme is further classified into the GreenTRACK line, represented by tracks for mobile machinery, a line of tyre chains for tractors and similar machinery, and a line of choker chains and similar logging supplies, designed for harvesting wood. All products from the VERIGAforest programme are distinguished by high-quality craftsmanship and treatment, providing a long service life.

GreenTRACK

GreenTRACK tracks for forestry machinery, with stronger traction on different types of terrain and for tyre protection. A special feature of the GreenTRACK products is heat treatment, which provides an equal hardness also on welding links.

VERIGAsport

The sport programme is a carefully thought-out additional range developed under the watchful eye of our professional associates. We were the first to introduce leisure crampons to the world. Due to extremely positive feedback from our satisfied users, we began to focus more and more resources and marketing activities on the recognition of VERIGAsport brand with the ultimate goal and wish: to get closer to our end users.

HINTS FOR CHOOSING CHAINS

What does the labeling on your tyres mean?
On the side of your tyre you can find a label of the tyre type: **225/45 R 17 91V**

- Example:**
- 225:** Tyre width in mm
 - 45:** Aspect ratio between the width and the height in %
 - R:** Tyre design – Radial tyre
 - 17:** Rim diameter in inches
 - 91:** Load index
 - V:** Velocity symbol for the maximum allowed highspeed

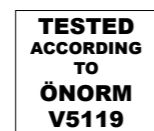

VERIGA: OUR HISTORY

28



TRACTIVA: CONCEPT



30

TRACTIVA: TECHNOLOGY

32



TRACTIVA: MODELS



34

TRACTIVA AVTO

35



TRACTIVA SPORT



36

TRACTIVA SUV

37



TRACTIVA SPARES

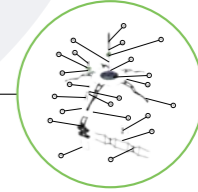

38

TRACTIVA TYRE TABLES

42

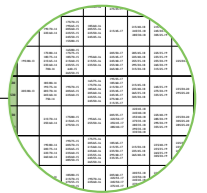

TRACTIVA VAN

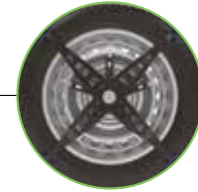

42

TRACTIVA CARGO

44



TRACTIVA PRO



45



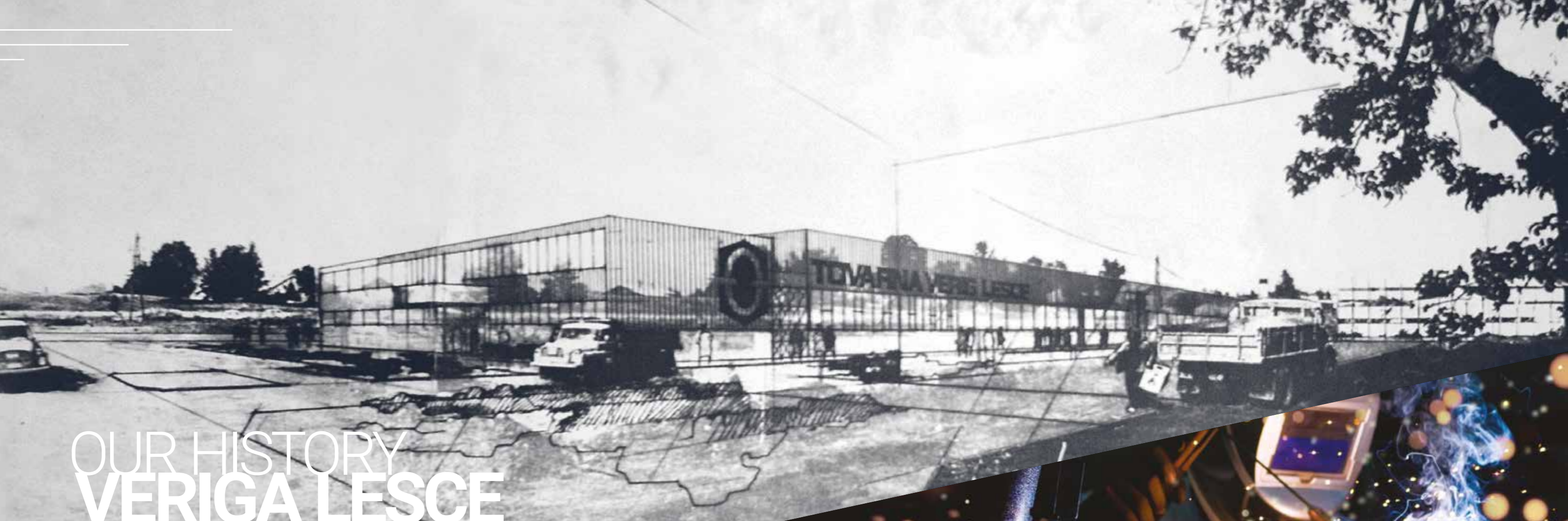

OUR HISTORY VERIGA LESCE

The factory Veriga was established in 1922. The production programme included screws, forgings, heavy anchor chains, forestry towing chains, transport chains for mining, and various chains by metre, from thickness of 1 mm up to 100 mm. Later, the production expanded onto snow chains and protection chains for tractors and heavy machinery, as well as snow chains for automobiles. In 1992, the chain RIVAL COMPACT has been created, patented and certified. It remains in the production of the company to this day.

Such a production programme combined with the quality of products placed Veriga among the largest manufacturers in the European and global markets. This is why the factory also manufactured chains for other renowned brands of chains. In those times, Veriga employed over 1,500 workers. In 1998, the company went through a privatisation process and was renamed into VERIGA K.F., d.o.o.

NOWADAYS, THE PRODUCTION PROGRAMME CONTAINS:

- Snow chains for cars, light delivery vehicles, 4x4s, lorries, tractors, and heavy machinery.
- Forestry chains for tractors and heavy machinery chains for wood towing.
- Tracks for forestry machinery
- Protective chains for heavy machinery.
- Walking crampons for shoes.

The products are sold both on the domestic and global markets. With every passing year, Veriga is increasingly successful at competing with the largest global manufacturers of chains, while the company's own brand VERIGA is also getting more and more recognition at the same time.

SINCE 1922



TRACTIVA

TRACTIVA: The Evolution of the Snow Chain.

In collaboration with the former developer and designer of the Trak chain, we present the evolution of the classic snow chain – the Veriga Tractiva.

Stronger, simpler, more resilient and more efficient, Veriga Tractiva combines the many hours of research, testing, improvements and corrections that have gone into developing the most reliable chain ever, and one that is also easy to use.

1. AUTOMATIC MOUNTING – spring effect

The secret of the fast, self-locking mounting lies in the specific heat treatment of the steel arms, which, with their spring effect, secure the chain to the wheel even in the most unforgiving conditions.

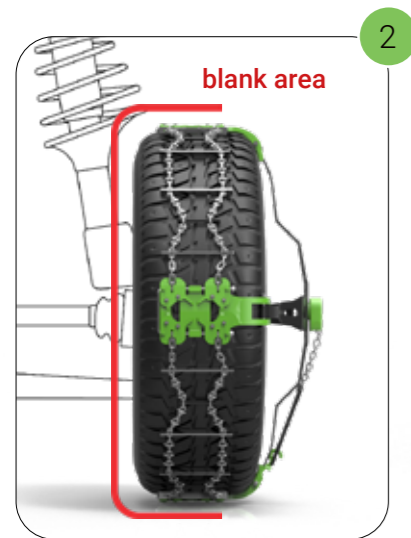

2. ZERO CLEARANCE – for all types of cars

The Veriga Tractiva is an excellent choice for most modern cars. Since it doesn't protrude to the inside of the wheel, it is also suitable for vehicles where conventional chains cannot be fitted, as they could interfere with the transmission or brakes.



3. MORE GRIP – on snow and ice

Thanks to special polyurethane guides and tungsten carbide spikes, Veriga Tractiva has outstanding grip on slippery surfaces. Additional grip in the most demanding conditions is provided by special square-shaped chain sections with transverse metal bars.

4. AUTO TENSIONING – suitable for all tires

The special rubber tensioning elements on the Tractiva allow the chain to be used and fit on both new and worn tires, while the smart self-tensioning function ensures a perfect fit.



5. A COMPLETE RANGE – for all cars

Thanks to clever design features and efficient production, finding the right dimensions for your vehicle will be a piece of cake, as a relatively small number of products cover more than 90% of the tires on the market. In addition, there is a high probability that one set of Tractiva chains will fit several vehicles, or that the chains will still fit even if the vehicle is replaced. The entire range of passenger cars is covered with 13 part numbers, 6 for SUVs and sports cars and 7 for other vehicles.

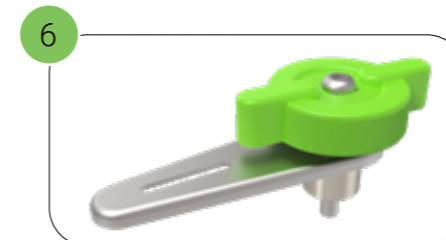

6. QUICK MOUNTING – the Tractiva fixing system

No special bolts or fittings to install in advance, no special tools to tighten the chain; all you need to attach the chain to the wheel nut is your hands. Fewer components are needed for the whole system, which also means optimized production, less raw materials used and a smaller carbon footprint.



TRACTIVA

TRACTIVA TECH: technology and solutions for safe winter driving.



1

1. TRACTIVA FIXING SYSTEM

The two-stage clamping system first converts the circular motion into a wheel nut clamping motion, while subsequently, a more advanced system uses the leverage effect for an even stronger and more secure fix.



2

2. THE INNOVATIVE PATENTED "CLE" MECHANISM

A special mechanism allows quick mounting and dismounting using a lever. This ensures a firm and reliable fix to the wheel nut without additional tools.



3. CLAMPING TECHNOLOGY

The reliability of our system is based on specially designed grippers with grooves that fit 95% of the cars on the market.



3

4. SMART GRIPPERS

The angles β and γ have been carefully studied, so that the gripper perfectly aligns with most of the wheel nuts.

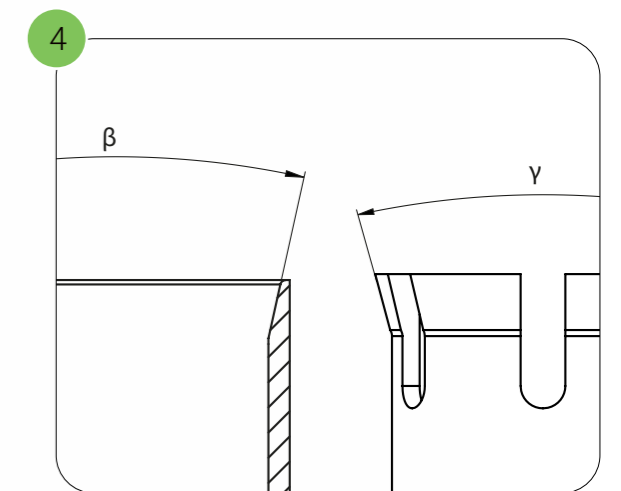

4

5. SINGLE POINT OF FIXING

The chain can be mounted to the wheel by clamping on just one wheel nut, without the need for any other attachments. The added spacers allow adjustment and mounting even on rims with extremely positive or negative offsets.



5



MODEL SUMMARY



CODE	A09 - A17	S11 - S17	U49 - U55	V10-V110	TC-T6-T29	TP-T20-T29
MODEL	TRACTIVA AUTO	TRACTIVA SPORT	TRACTIVA SUV	TRACTIVA VAN	TRACTIVA CARGO	TRACTIVA PRO
RECOMMENDED FOR						
CLEARANCE ACCORDING TO EN 16662-1	0/16	0/12	0/16	0/16	0/22	0/22
MAXIMUM INNER CLEARANCE	0	0	0	0	0	0
MAXIMUM SURFACE CLEARANCE	16	12	16	16	22	22
AUTOMATIC TENSIONING	✓	✓	✓	✓	✓	✓
AUTOMATIC MOUNTING	✓	✓	✓	✓	✓	✓
EASE OF MOUNTING	10 ★★★★★★ ★★★★★★	10 ★★★★★★ ★★★★★★	10 ★★★★★★ ★★★★★★	10 ★★★★★★ ★★★★★★	10 ★★★★★★ ★★★★★★	10 ★★★★★★ ★★★★★★
LEVEL OF TRACTION	10 ★★★★★★ ★★★★★★	9 ★★★★★★ ★★★★★★	9 ★★★★★★ ★★★★★★	9 ★★★★★★ ★★★★★★	10 ★★★★★★ ★★★★★★	10 ★★★★★★ ★★★★★★
DRIVING COMFORT	9 ★★★★★★ ★★★★★★	10 ★★★★★★ ★★★★★★	9 ★★★★★★ ★★★★★★	9 ★★★★★★ ★★★★★★	9 ★★★★★★ ★★★★★★	10 ★★★★★★ ★★★★★★

TRACTIVA AUTO



With a link height of 16 mm, the Tractiva Auto is the strongest and most durable chain in the Tractiva range.

- Approved according to EN 16662-1 and ONV5117.
- Innovative tread mesh construction.
- Case-hardened chain parts with rubber tensioners and special transverse traction bars.
- Polyurethane guides with carbide spikes.
- Tractiva smart wheel fitting system.
- Screw set and user guide.
- Nylon bag and cardboard packaging.

DIMENSIONS

	D [mm]	4
	H [mm]	16

PACKAGING



TRACTIVA SPORT



With a link height of only 10 mm, the Tractiva Sport is the lightest and most compact chain in the Tractiva range.

- Approved according to EN 16662-1 and ONV5117.
- Innovative tread mesh construction.
- Case-hardened chain parts with rubber tensioners and special transverse traction bars.
- Polyurethane guides with carbide spikes.
- Tractiva smart wheel fitting system.
- Screw set and user guide.
- Nylon bag and cardboard packaging.

DIMENSIONS

	D [mm]	3
	H [mm]	10

PACKAGING



TRACTIVA SUV



With a link height of 16 mm, the Tractiva SUV is built for the most extreme conditions. Additionally, the D-profile links will give your SUV the extra grip it needs to battle snow and ice.

- Approved according to EN 16662-1 and ONV5117.
- Innovative tread mesh construction.
- Case-hardened chain parts with rubber tensioners and special transverse traction bars.
- Polyurethane guides with carbide spikes.
- Tractiva smart wheel fitting system.
- Screw set and user guide.
- Nylon bag and cardboard packaging.

DIMENSIONS





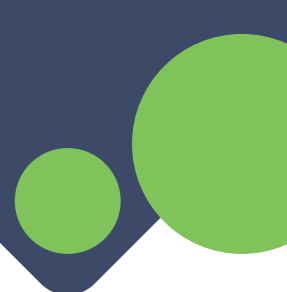



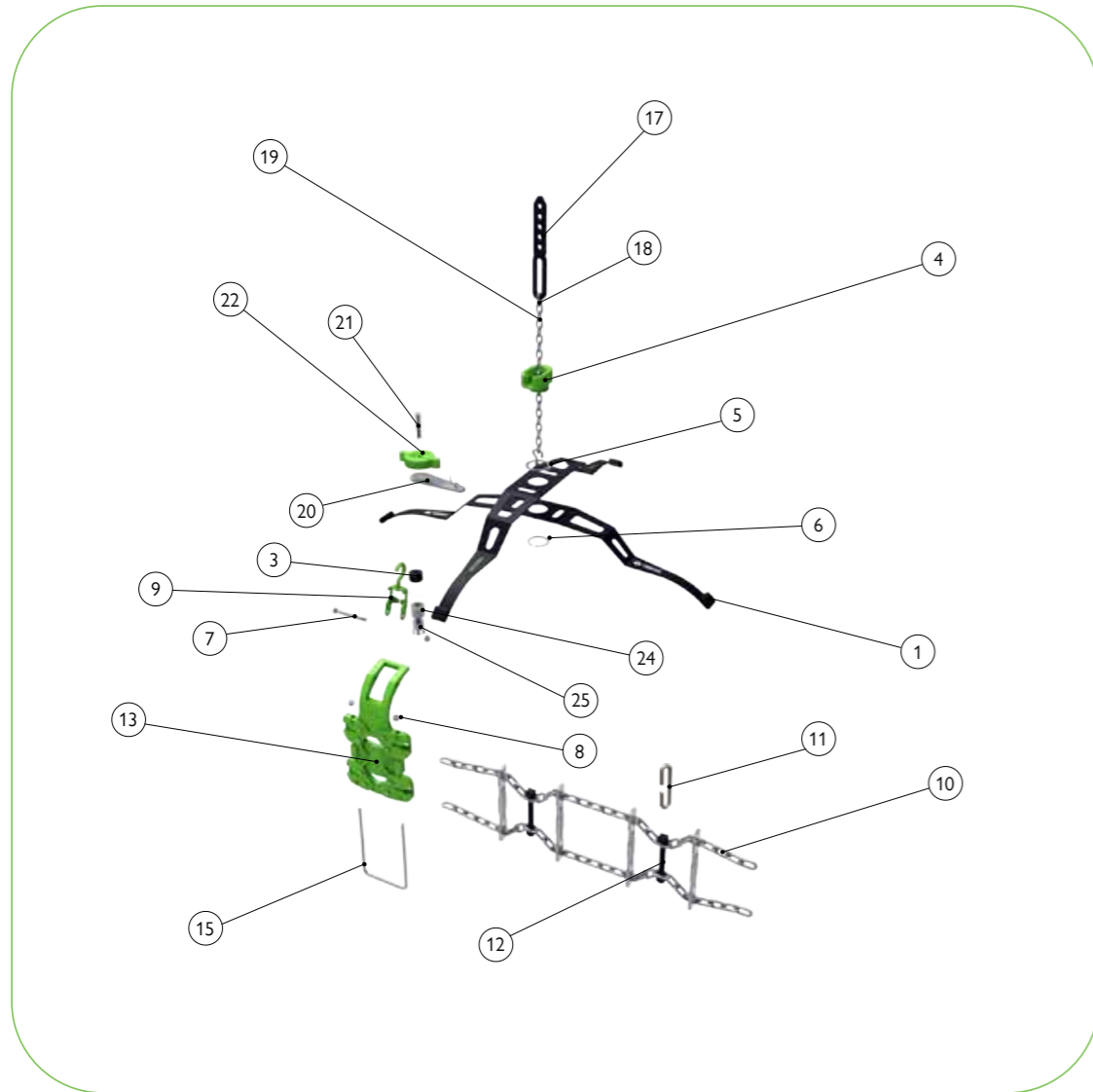



	D [mm]	4
	H [mm]	16

PACKAGING





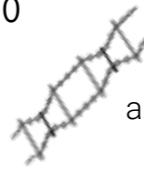









AUTO, SPORT & SUV



spare parts	codes	description	spare parts	codes	description
1 	47895 RT-A10 47896 RT-A20 47897 RT-A30 47898 RT-A40 47899 RT-A50 47900 RT-A60 47901 RT-A70	Tractiva metallic arm for Auto and Sport models	6 	43828 (100 00 003)	Circlip for metallic arms
2 	47902 RT-U10 47903 RT-U20 47904 RT-U30 47905 RT-U40 47906 RT-U50 47907 RT-U60	Tractiva metallic arm for SUV model	7 	43829 M5X50	M5 x 50 connecting screws
3 a.  b. 	a. 43846 DDT b. 43847 DKT	a. Long spacer b. Short spacer	8 a.  b. 	a. 43830 (M5 MATICA) b. 43831 (M3,5 MATICA)	a. M5 galvanized nut b. M3.5 galvanized nut
4 	43826 ZCT	Center chain stop	9 	43832 KNVT	Metallic hook for Tractiva tightening chain
5 	43827 TPRT	Teflon washer for arms	10 a.  b. 	43918-43 43873-40 43871-42 43874-39 43872-41 43875-38 43619-32 43880-28 43877-31 43881-27 43878-30 43882-26 43879-29	Chain section for: a. Sport model b. Auto & SUV models







SPARE PARTS

SUMMARY

spare parts	codes	description	spare parts	codes	description
11 	43834 CST	Cross chain link for shortening	16 	43857 SNT	Complete Tractiva fixing system
12 a.  b. 	a. 43835 GTS b. 43836 GTAS	a. Rubber tensioner for Sport model b. Rubber tensioner for Auto and SUV models	17 	43839 GNT	Rubber tensioner for Tractiva system
13 a.  b. 	a. 43837 EVTAS b. 43838 EVTS	a. Guides for Auto and SUV models b. Guides for Sport model	18 	43840 COT	Open chain link for tightening
14 a.  b. 	a. 26982 b. 43885	a. 6 x 30 mm split pin b. Chain link connecting pin	19 	43841 VNT	Tractiva system tightening chain and hook
15 	43886	Steel bracket for Sport model	20 	43842 PCT	Tractiva system metallic lever

SPARE PARTS

SUMMARY

spare parts	codes	description	spare parts	codes	description
21 a.  b. 	a. 43843 M8x60 b. 43844 M8x95	a. M8 x 60 screw b. M8 x 95 screw	24 	a. 43851 D-17-T b. 43852 D-19-T c. 43853 D-21-T d. 44209 D-22-T	a. 17 mm gripper socket clamp b. 19 mm gripper socket clamp c. 21 mm gripper socket clamp d. 22 mm gripper socket clamp
22 	43845 KMT	Tractiva system mounting wheel	25 	a. 43854 V-17-T b. 43855 V-19-T c. 43856 V-21-T d. 44210 V-22-T	a. 17 mm complete gripper socket b. 19 mm complete gripper socket c. 21 mm complete gripper socket d. 22 mm complete gripper socket
23 	a. 43848 O-17-T b. 43849 O-19-T c. 43850 O-21-T d. 44208 O-22-T	a. 17 mm gripper socket housing b. 19 mm gripper socket housing c. 21 mm gripper socket housing d. 22 mm gripper socket housing	26 	49126	gripper socket universal

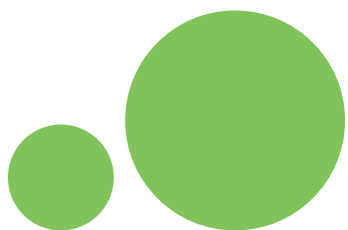

TRACTIVA AUTO & SPORT

DIMENSION PROGRAM

CHAIN N°	13' - 14'	15'	16'	17'	18'	19'	20'	21' - 24'	
AUTO TA 10 SPORT TS 10	175/80-13 S1 235/60-13 S1 255/55-13 S1 165/80-14 S4 175/75-14 S3 185/70-14 S2 195/65-14 S1 205/65-14 S4 215/60-14 S2	165/70-15 S1 175/65-15 S1 185/60-15 185/55-16 S1 195/55-16 S4 205/50-16 S1 205/55-15 215/55-15 S3 215/45-16 225/50-15 235/50-15 S2 255/45-15 S1 265/45-15 S4 285/40-15 S1 345/35-15 S4	175/60-16 S2 185/55-16 S1 195/55-16 S4 205/50-16 S1 215/45-16 225/45-16 S1 235/45-16 S3 255/40-16 S1 265/40-16 S3	175/55-17 S4 185/50-17 S3 195/45-17 205/45-17 S2 215/40-17 225/40-17 S1 235/40-17 S4 245/35-17 255/35-17 S1 265/35-17 S3 275/35-17 S4	205/40-18 S4 215/35-18 225/35-18 S2 235/35-18 S4 245/30-18 255/30-18 S1 265/30-18 S2	225/30-19 S3 235/30-19 S4	275/20-20 S3		
AUTO TA20 SPORT TS20	185/80-13 195/80-13 S4 165/80-14 S4 175/75-14 S3 185/70-14 S2 195/65-14 S1 215/65-14 S2 225/60-14 235/60-14 S2	155/80-15 185/70-15 S3 195/65-15 S2 205/60-15 215/60-15 S3 225/55-15 235/55-15 S3 245/50-15 265/50-15 S4 275/45-15	185/60-16 205/55-16 S1 225/50-16 S1 235/50-16 S3 245/45-16 255/45-16 S2 275/40-16	205/50-17 S2 215/45-17 225/45-17 S1 245/40-17 255/40-17 S2 285/30-18 295/30-18 S1	205/45-18 S4 215/40-18 225/40-18 S2 245/35-18 255/35-18 S2 285/30-18 295/30-18 S1	215/35-19 S1 225/35-19 S3 245/30-19 255/30-19 S2 265/30-19 S4 305/25-19 S2 315/25-19 S3		225/30-20 S4 275/25-20 S4	
AUTO TA30	195/75-13	165/80-15 175/75-15 175/80-15 S4 185/75-15 S4 205/65-15 S1 215/55-16 215/65-15 S4 225/60-15 S2 270/50-15 S2 275/50-15 S3	165/75-16 S3 175/70-16 S2 185/65-16 S1 195/60-16 205/60-16 S2 215/55-16 225/55-16 S3 245/50-16 S2 250/50-16 S3 255/50-16 S4	175/65-17 S4 185/60-17 S3 195/55-17 205/55-17 S3 215/50-17 S1 225/50-17 S3 235/45-17 245/45-17 S2 255/45-17 S4 265/40-17 275/40-17 S2 285/40-17 S4 315/35-17 S2	175/55-18 S2 195/50-18 S2 215/45-18 S2 225/45-18 S4 235/40-18 245/40-18 S2 255/40-18 S4 265/35-18 275/35-18 S2 285/35-18 S3 315/30-18 325/30-18 S2 335/30-18 S4	235/35-19 S1 245/35-19 S3 275/30-19 S1 285/30-19 S3 295/30-19 S4 335/25-19 S2 355/25-19 S4	235/30-20 S1 245/30-20 S3 255/30-20 S4 285/25-20 S2 295/25-20 S3		
AUTO TA40 SPORT TS40	195/80-14 S2 265/60-14 S4	195/70-15 195/75-15 S4 225/65-15 S4 235/60-15 S1 245/60-15 S4 285/50-15 S2	175/75-16 195/65-16 215/60-16 S1 220/60-16 S3 225/60-16 S4 235/55-16 S2 245/55-16 S2 265/50-16 S3	185/65-17 S3 195/60-17 S2 215/55-17 S2 235/50-17 S2 265/45-17 S3 295/40-17 S2 335/35-17 S2	195/55-18 S3 205/50-18 S1 215/50-18 S3 235/45-18 S3 265/40-18 S3 295/35-18 S1	225/40-19 S1 235/40-19 S3 255/35-19 305/25-20 315/25-20 S2 325/25-20 S3	225/35-20 S2 265/30-20 S2 305/25-20 315/25-20 S2 325/25-20 S3	235/30-21 S4 275/25-21 S3	
AUTO TA50 SPORT TS50	205/80-14 S4 215/75-14 S3	185/80-15 S3 205/70-15 275/55-15 S4 295/50-15 S2	195/70-16 S3 205/65-16 S2	205/60-17 S3 225/55-17 S3 245/50-17 S3 275/45-17 S3	205/55-18 S4 225/50-18 S4 245/45-18 S3 275/40-18 S3 315/35-18 S3	195/50-19 S3 245/40-19 S3 275/35-19 S2 285/35-19 S4 325/30-19 S3 335/30-19 S4	225/40-20 S3 235/35-20 S2 245/35-20 S3 275/30-20 S2 285/30-20 S3 335/25-20 S2 345/25-20 S4	245/30-21 S3 295/25-21 S4 375/20-21 S4	
AUTO TA60 SPORT TS60	215/80-14 S1	195/80-15 S4 205/75-15 S3 215/70-15 S2 235/65-15 S3 255/60-15 S3 305/50-15 S2	175/80-16 S2 205/70-16 S4 255/55-16 S3	185/70-17 S4 255/50-17 S3	195/60-18 S4 255/45-18 S3 285/40-18 S2 295/40-18 S4	175/60-19 S4 205/50-19 S3 225/45-19 S2 255/40-19 S3 295/35-19 S3 345/30-19 S4	155/60-20 S4 265/35-20 S3 265/35-20 S4	255/30-21 S2 265/30-21 S4 255/25-22 S2	
AUTO TA70 SPORT TS70		205/80-15 S4 215/75-15 S2 225/70-15 235/70-15 S4 245/65-15 S1 275/60-15 S4	185/75-16 195/75-16 S1 215/65-16 215/70-16 S3 225/65-16 S1 235/60-16 245/60-16 S1 275/55-16 S4 295/50-16 S2	205/65-17 S1 215/60-17 215/65-17 S4 225/60-17 S2 235/55-17 245/55-17 S2 275/50-17 S3	215/55-18 235/50-18 245/50-18 S2 245/45-19 S2 265/45-18 275/45-18 S3 345/35-18 S1	205/55-19 S3 215/50-19 S1 225/50-19 S3 235/45-19 245/45-19 S2 265/40-19 275/40-19 S2 285/40-19 S4 305/35-19 325/35-19 S4	175/55-20 195/50-20 S2 215/45-20 S2 225/45-20 S4 245/40-20 S2 255/40-20 S4 275/35-20 S2 285/35-20 S3 295/30-20 305/30-20 315/30-20 S1 325/30-20 S2 335/30-20 S4	245/35-21 S3 255/35-21 S4 275/30-21 S1 285/30-21 S2 295/30-21 S4 325/25-21 345/25-21 S3 355/25-21 S4 235/30-22 S1 245/30-22 S3 255/30-22 S4 275/25-22 285/25-22 S2 295/25-22 S3 305/25-22 S4	

There are 4 shortenings on the chain.
S1-S4 = number of shortenings that can be removed if needed.

TRACTIVA 4x4 SUV & VAN

DIMENSION PROGRAM

CHAIN N°	14' - 15'	16'	17'	18'	19'	20'	21' - 24'	CHAIN N°	14' - 19'
SUV TU10	255/70-14 265/70-14 S4 225/75-15 S2 235/70-15 S4 245/70-15 S3 255/65-15 265/65-15 S4	195/80-16 S2 195/85-16 S4 205/75-16 S1 225/70-16 S2 235/60-16 235/65-16 245/65-16 S4 255/60-16 265/60-16 S3	205/70-17 S2 215/65-17 S4 225/65-17 S3 235/60-17 S1 245/60-17 S4 255/55-17 265/55-17 S3 315/45-17 S1	215/60-18 S1 235/55-18 S1 245/55-18 S4 255/50-18 265/50-18 S3 285/45-18 S1 295/45-18 S3	205/55-19 S3 215/55-19 S2 235/50-19 S2 255/45-19 265/45-19 S2 295/40-19 S2 345/35-19 S3	195/55-20 S3 235/45-20 S2 245/45-20 S4 255/40-20 S4 265/40-20 S2 285/35-20 S3 295/35-20 S1 305/35-20 S3 345/30-20 S1	265/35-21 S2 275/35-21 S4 305/30-21 S1 315/30-21 S3 265/30-22 S2 275/30-22 S3 315/25-22 S1 335/25-22 S4		VAN TV10 175/70-14 185/60-15 195/60-15 S2 195/55-16 S4
SUV TU20	215/80-15 S1 235/75-15 S4	215/75-16 235/70-16 S4 275/60-16 S4	215/70-17 S3 235/65-17 S4 275/55-17 S4	225/60-18 S2 235/60-18 255/55-18 S4 275/50-18 S3	245/50-19 S2 255/50-19 S4 275/45-19 S2 285/45-19	275/40-20 S2 285/40-20 S4 315/35-20 S2 325/35-20 S4	245/40-21 S2 255/40-21 S4 285/35-21 S3 325/30-21 S2 245/35-22 S2 255/35-22 S4 285/30-22 S2 295/30-22 S4 305/25-23 S4		VAN TV20 185/65-15 S4 195/65-15 S2 205/55-16 195/60-16 205/50-17 S2
SUV TU30	225/80-15 S1 255/70-15 265/70-15 S4 275/65-15	205/80-16 205/85-16 S4 215/80-16 S3 225/75-16 S2 225/80-16 S4 245/70-16 S3 255/65-16 265/65-16 S3 285/60-16 S3	195/80-17 S2 205/75-17 245/65-17 S3 255/60-17 265/60-17 S3	225/65-18 S3 245/60-18 S3 265/55-18 S3 285/50-18 S1	225/55-19 S2 235/55-19 S1 245/55-19 S4 265/50-19 S3 295/45-19 S3	235/50-20 S1 245/50-20 S4 295/40-20 S2 305/40-20 S4	195/55-21 S3 235/45-21 S2 245/45-21 S4 265/40-21 S2 295/35-21 S1 315/35-21 S4 345/30-21 S1 265/35-22 S2 275/35-22 S3 305/30-22 S1 315/30-22 S3 275/30-23 S3 315/25-23 S1 275/25-24 S2 285/25-24 S4		VAN TV30 195/70-15 205/60-16 S2 215/55-16 215/50-17 S1
SUV TU40	245/75-15 255/75-15 S4 275/70-15	235/75-16 S3 255/70-16 S4 275/65-16 S4	225/70-17 235/70-17 S3 255/65-17 S4 275/60-17 S4	235/65 18 S4 255/60 18 S4	235/60-19 S4 255/55-19 S4 275/50-19 S2	195/65-20 S4 255/45-20 265/45-20 275/45-20 S2	305/35-21 255/40-22 S4 285/35-22 S2 295/30-23 S3 255/30-24 S4		VAN TV40 215/65-15 S4 195/65-16 215/60-16 S1 205/55-17 S3 215/55-17 S2 225/45-18 S4
SUV TU50	265/75-15 S3 275/75-15 S3 325/60-15 S1	245/75-16 S2 215/85-16 S1 235/80-16 S4 265/70-16 S2 285/65-16 S2	225/75-17 235/75-17 S4 245/70-17 S2 265/65-17 S2 285/60-17 S2	225/70 18 S1 265/60 18 S2 285/55 18 S1	265/55-19 S2 275/55-19 S4 285/50-19	235/55 20 0 265/50 20 S1 285/45 20 295/45 20 S2	235/50-21 255/45-21 S4 265/45-21 S1 275/40-21 S1 285/40-21 265/40-22 S1 295/35-22 305/35-22 S1 315/35-22 S3 285/35-23 S4 305/30-23 315/30-23 S1 325/30-23 S3 275/30-24 S2 285/30-24 S4		VAN TV50 215/70-15 S2 205/65-16 S2 225/55-17 S3 245/45-18 S3
SUV TU60	245/85-15 S4 32X11.5 15	225/85-16 S2 255/75-16 S2 275/70-16 S2 280/70-16 S4	245/75-17 S4 255/70-17 S2 265/70-17 275/65-17 S2	255/65-18 S2 275/60-18 S1 285/60-18 S4	235/65-19 S2 255/60-19 S2 285/55-19 S4	235/60-20 S2 255/55-20 S2 275/50-20 275/55-20 285/50-20 S3 305/45-20	255/50-21 S2 275/45-21 285/45-21 S2 295/40-21 315/40-21 S4 255/45-22 S2 275/40-22 275/45-22 285/40-22 S1 295/40-22 S4 325/35-22 S1 265/40-23 S4 285/40-23 295/35-23 S2 305/35-23 S4 315/30-24 S4		VAN TV60 235/55-17 215/60-17 255/45-18 S3
									VAN TV70 225/70-15 195/75-16 S1 215/65-16 225/65-16 S1 245/45-19 S2
									VAN TV80 205/75-16 S1 235/65-16
									VAN TV90 215/75-16
									VAN TV100 225/75-16 S2
									VAN TV110 255/65-17 S4 255/60-18 S4
									VAN TV120 245/75-16 S2

There are 4 shortenings on the chain.
S1-S4 = number of shortenings that can be removed if needed.

TRACTIVA VAN



This chain with quick assembly, automatic tensioning and no clamping at the back is the right choice for all those who are going on a winter adventure in a motorhome. It is also suitable for all delivery vehicles, as it provides better traction and greater stability on snowy and icy roads with 16 mm D-links.

- Homologated according to EN 16662-1 and ONV5117.
- Innovative mesh construction of the tread.
- Cemented chain parts with rubber tightening elements and special transverse profiles for better traction.
- A system of 4 levers and steel carbon tips on 4 polyurethane guides.
- A special, patented clamping method.

Packaging: 1 pair in a nylon bag and carton packaging.

DIMENSIONS

	D [mm]	4
	H [mm]	16

PACKAGING



TRACTIVA CARGO



Cargo vehicle chain with fast assembly. Equipped with a D profile chain link of 6 mm, Tractiva CARGO is a solution with the fastest mounting for all trucks. Fitted from the outside of the tyre, with 4 arms configuration and steel carbon spikes on 4 plastic guides. Tractiva Cargo is both an emergency and a long run chain.

- Tested according ON V5119;
- Innovative patented hooking solution.
- Case hardened chain with metal grip bars and shortening screws for regulation.
- Polyurethane guides with carbon spikes.
- Operating instructions enable fast assembly.

Packing: Nylon bag for each half of the pair.

DIMENSIONS

	D [mm]	6
	H [mm]	22

TRACTIVA PRO



Equipped with a D profile chain link of 6 mm, Tractiva Pro is the professional solution with a maximum grip thanks to the 6 arms configuration and carbene spikes on 6 plastic guides.

Suitable for the most exigent drivers, for international routes, for any occasion where a fast mounting and dismounting is a must.

- Tested according ON V5119.
- Innovative patented hooking solution.
- Case hardened chain with metal grip bars and shortening screws for regulation.
- Polyurethane guides with carbene spikes.
- Operating instructions enable fast assembly.

Packing: Nylon bag for each half of the pair.

DIMENSIONS

	D [mm]	6
	H [mm]	22

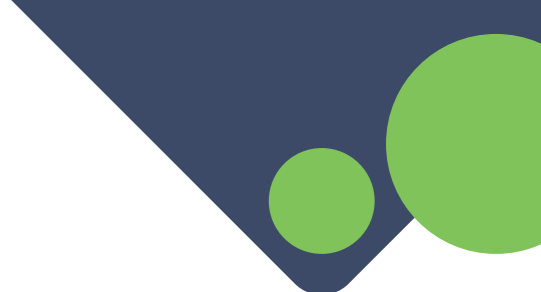



VERIGAsnow

VERIGAsnow umfasst Reifenketten für den professionellen und gelegentlichen Einsatz – von Pkw, Gelände- und Lieferfahrzeugen, Bussen, Lkw, Traktoren bis hin zu allen anderen Arbeitsmaschinen. Unsere Winterreifenketten sind das Zubehör, das Ihnen noch mehr Griff und eine sicherere Fahrt auf verschneiten und vereisten Oberflächen bietet. Wir sind einer der weltweit führenden Hersteller von Schneeketten mit langer Tradition, hochwertiger Verarbeitung und langer Produktlebensdauer.

NordicLINE

Die Produktlinie wird für Länder entwickelt, in denen die Verwendung von »gezahnten« Ketten auf den Straßen erlaubt ist. Das CAM-Schließsystem ermöglicht eine schnelle und einfache Montage.

PremiumLINE

Die Produktlinie, die mit innovativer Konstruktion, hochwertigen Materialien und Produktionsprozessen für herausragende Qualität und lange Lebensdauer sorgt.

VERIGAtpc

VERIGAtpc ist ein Programm von Reifenschutzketten für schwere Arbeitsmaschinen in Bergwerken, Steinbrüchen und Deponien, bei denen der Hauptzweck der Ketten der Schutz des Reifens ist. Diese Nische stellt einen ständig steigenden Umsatzanteil dar und potenzielle Käufer kommen aus der ganzen Welt (Europa, Süd- und Nordamerika, Asien, Australien,...).

VERWENDUNG VON KETTEN IN EUROPA

- Gesetzliche Mitführpflicht
- Mitführpflicht bei winterlichen Verhältnissen

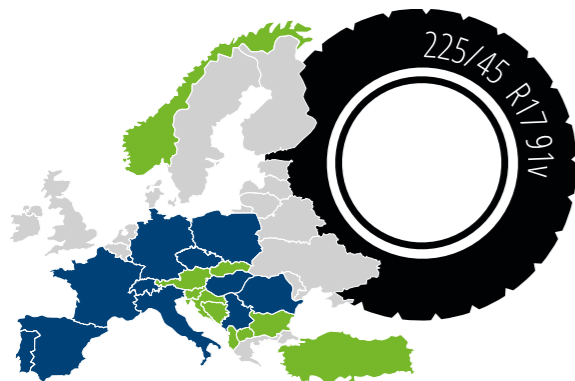

VERIGAforest

Wälder bedecken 31 % der globalen Landschaft, allein in Europa sind es etwa 40 %. Zu diesem Zweck haben wir eine breite Produktpalette für den allgemeinen und professionellen Einsatz in der Forstwirtschaft entwickelt. Da die Forstwirtschaft praktisch eine Ganzjahresbeschäftigung ist und nicht so saisonal wie das Schneeprogramm, bietet sie ein großes Potenzial. Das VERIGAforest-Programm ist weiter in die GreenTRACK-Linie unterteilt, die durch Raupenketten für mobile Maschinen, eine Reihe von Reifenketten für Traktoren und ähnliche Maschinen sowie eine Reihe von Chokerketten und ähnlichem Holzeinschlagzubehör für die Holzerte repräsentiert wird. Alle Produkte aus dem VERIGAforest-Programm zeichnen sich durch hochwertige Handwerkskunst und Verarbeitung aus und bieten eine lange Lebensdauer.

GreenTRACK

Traktionsbänder für Forstmaschinen. Die GreenTRACK Traktionsbänder wurden für mehr Haftung auf verschiedenen Untergründen und für den Reifenschutz entwickelt. Die Besonderheit der GreenTRACK-Produktlinie liegt in einem speziellen Wärmebehandlungsverfahren, das auch an Schweißnähten eine gleichmäßige Härte gewährleistet.

VERIGAsport

Das Sport-Programm ist ein durchdachtes Zusatzangebot, das unter den wachsamen Augen unserer professionellen Mitarbeiter entwickelt wurde. Wir waren die ersten, die Freizeitsteigeisen der Welt vorgestellt haben. Aufgrund des äußerst positiven Feedbacks unserer zufriedenen Benutzer haben wir begonnen, immer mehr Ressourcen und Marketingaktivitäten auf die Wiedererkennung der Marke VERIGAsport zu konzentrieren, mit dem ultimativen Ziel und Wunsch: näher an unsere Endverbraucher zu kommen.

TIPPS ZUR KETTENAUSWAHL

Was bedeuten die Bezeichnungen auf den Reifen?

Seitlich auf den Reifen sind Bezeichnungen zur Reifengröße und Bauart. Beispiel: **225/45 R 17 91V** Bedeutung:

- 225:** Reifenbreite in mm
- 45:** Reifenquerschnitt
- R:** Reifenbauart – Radialreifen
- 17:** Felgendurchmesser in Zoll
- 91:** Tragfähigkeitskennzahl
- V:** Geschwindigkeitssymbol für die maximal zulässige Höchstgeschwindigkeit

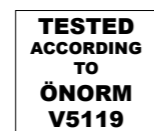

VERIGA: GESCHICHTE

50



TRACTIVA: KONZEPT

52



TRACTIVA: TECHNOLOGIE

54



TRACTIVA MODELLE

56



TRACTIVA AVTO

57



TRACTIVA SPORT

58



TRACTIVA SUV

59



TRACTIVA ERSATZTEILE

60



TRACTIVA DIMENSIONS PROGRAMM

64

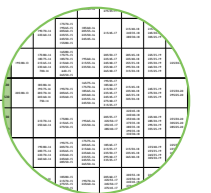

TRACTIVA VAN

64

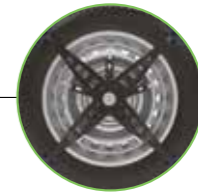

TRACTIVA CARGO

66



TRACTIVA PRO

67



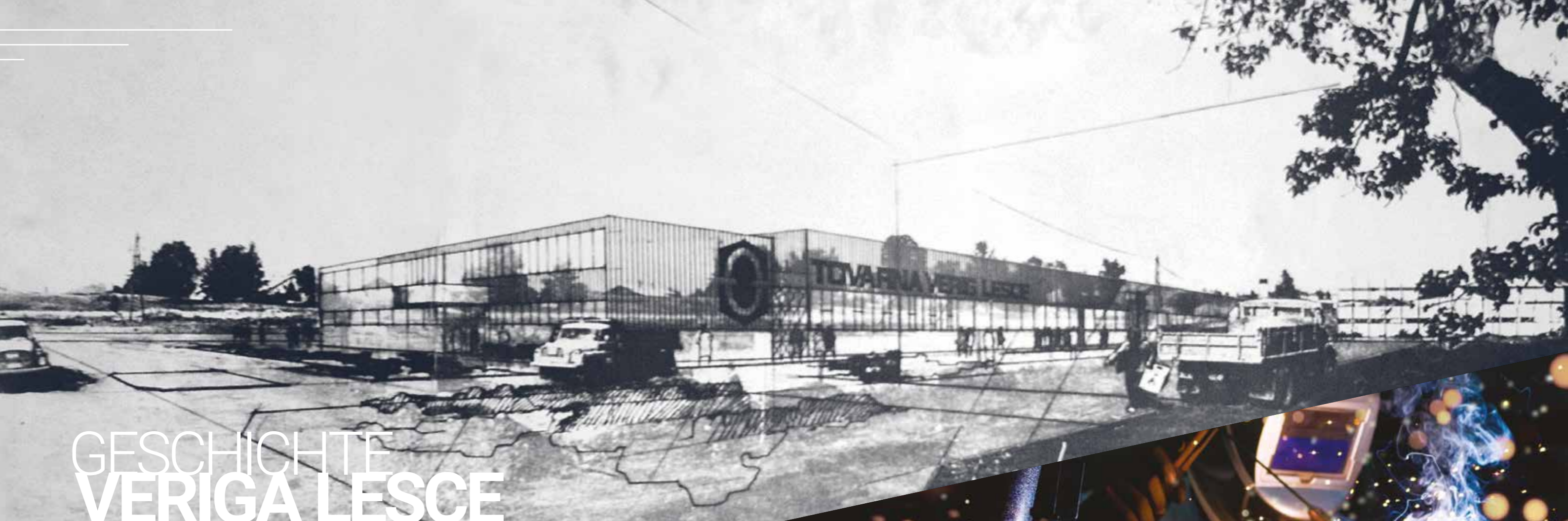

GESCHICHTE VERIGA LESCE

Die Veriga-Fabrik wurde 1922 gegründet. Im Laufe der Geschichte stellte das Unternehmen verschiedene Produkte her, konzentrierte sich jedoch hauptsächlich auf Schrauben, Schmiedeteile, schwere Ankerketten, forstwirtschaftliche Choker-Ketten, Bergbau-Transportketten und andere sortierte Ketten als Meterware mit einer Dicke von 1 mm bis 100 mm. Mit der Zeit wurde die Produktion auf Schutzketten für Traktoren und Arbeitsmaschinen sowie Schneeketten für PKWs erweitert. 1992 wurde der Vorläufer der modernen PKW-Kette, RIVAL COMPACT, entwickelt, patentiert und zertifiziert.

Ein gut geplantes Produktionsprogramm in Verbindung mit höchster Produktqualität machte Veriga zu einem der größten Hersteller in Europa und der Welt und damit zum Hersteller der Wahl für mehrere weltbekannte Marken von Ketten. Zu dieser Zeit beschäftigte Veriga mehr als 1500 Mitarbeiter. 1998 wurde das Unternehmen umstrukturiert und in VERIGA K.F., d.o.o. umbenannt.

DAS PRODUKTIONSPROGRAMM UMFASST:

- Schneeketten für PKWs, leichte Nutzfahrzeuge, 4x4s, LKWs, Traktoren und Arbeitsmaschinen;
- Forstketten für Traktoren und Arbeitsmaschinen zur Holzernte;
- Forstbänder für Forstmaschinen und angetriebene Holzanhänger;
- Reifenschuttketten für Arbeitsmaschinen;
- Trekking-/Wandersteigeisen und andere Sport zubehör.

Heute sind unsere Produkte auf der ganzen Welt zu finden. Mit jedem Jahr wird Veriga immer erfolgreicher im Wettbewerb mit den größten globalen Kettenherstellern, während gleichzeitig auch die Eigenmarke VERIGA immer mehr Bekanntheit findet.

SINCE 1922



TRACTIVA

TRACTIVA: Die Evolution der Schneekette.

In Zusammenarbeit mit dem ehemaligen Entwickler und Designer der Trak-Kette, präsentieren wir die Evolution der klassischen Schneekette – die Veriga Tractiva. Stärker, einfacher, belastbarer und effizienter. Veriga Tractiva vereint die vielen Stunden an Forschung, Tests, Verbesserungen und Korrekturen, die in die Entwicklung der zuverlässigsten Kette aller Zeiten geflossen sind, die zudem einfach zu bedienen ist.

1. AUTOMATISCHE MONTAGE – Federeffekt

Das Geheimnis der schnellen, selbstsichernden Montage liegt in der spezifischen Wärmebehandlung der Stahlarme, die mit ihrer Federwirkung die Kette auch unter den unerbittlichsten Bedingungen am Rad sichern.

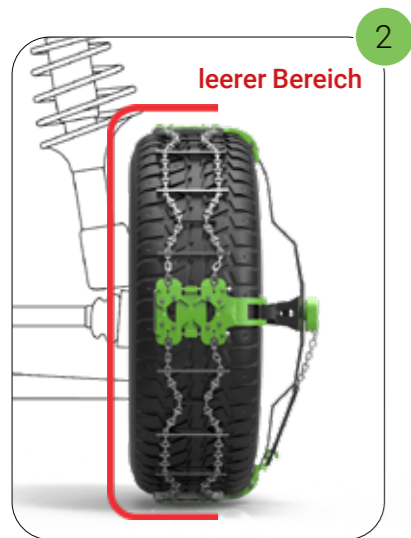

2. KEIN SPIELRAUM AUF DER INNENSEITE – für alle PKWs

Die Veriga Tractiva ist eine ausgezeichnete Wahl für den Großteil moderner Autos. Da sie nicht in den Radkasten ragt, ist sie auch für diejenigen Fahrzeuge geeignet, bei denen herkömmliche Ketten nicht montiert werden können, da sie das Getriebe oder die Bremsen beeinträchtigen könnten.



3. MEHR HAFTUNG – auf Schnee und Eis

Dank spezieller Polyurethan-Führungen und Spikes aus Wolframkarbid hat die Veriga Tractiva hervorragende Haftung auf rutschigem Untergrund. Zusätzliche Haftung unter anspruchsvollsten Bedingungen wird durch spezielle quadratische Kettenschnitte mit quer verlaufenden Metallstangen gewährleistet.

4. AUTOMATISCHE SPANNUNG – geeignet für alle Reifen

Durch die speziellen Gummispannelemente auf der Tractiva kann die Kette sowohl auf neuen als auch auf abgefahrenen Reifen verwendet und montiert werden, während die intelligente Selbstspannfunktion einen perfekten Sitz gewährleistet.



5. EIN KOMPLETTES SORTIMENT – für alle PKWs

Dank der cleveren Konstruktion der Tractiva, braucht es nur 13 verschiedene Größen (davon 6 für SUVs und Sportwagen) um fast die gesamte Breite an PKW Reifen zu decken. Die richtige Wahl wird damit zum Kinderspiel und die Kette wird mit größerer Wahrscheinlichkeit auch auf Ihren nächsten PKW passen.

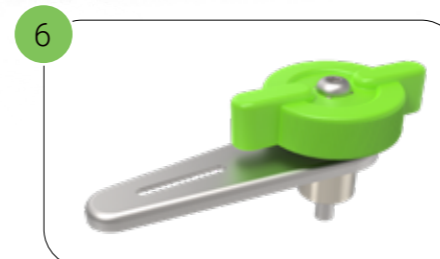

6. SCHNELLE MONTAGE – das Tractiva-Befestigungssystem

Ohne Adapter, die im Voraus installiert werden müssen und ohne Spezialwerkzeuge zum Spannen der Kette; alles, was Sie brauchen, um die Kette an der Radmutter zu befestigen, sind Ihre Hände. Für das gesamte System werden weniger Komponenten benötigt, was auch eine optimierte Produktion, weniger eingesetzte Rohstoffe und eine geringere CO2-Bilanz bedeutet.

TRACTIVA

TRACTIVA TECH: Technologie und Lösungen für sicheres Fahren im Winter.



1

1. DAS TRACTIVA-BEFESTIGUNGSSYSTEM

Das zweistufige Klemmsystem wandelt zunächst die kreisförmige Bewegung in eine Radmutterklemmung um, während anschließend ein fortgeschrittenes System die Hebelwirkung für eine noch stärkere und sicherere Befestigung nutzt.



2

2. DAS INNOVATIVE PATENTIERTE "CLE" MECHANISMUS

Unser spezieller Mechanismus ermöglicht eine schnelle Montage und Demontage mittels eines Hebels. Dies gewährleistet eine feste und zuverlässige Fixierung an der Radmutter ohne zusätzliches Werkzeug.



3. SPANNTECHNIK

Die Zuverlässigkeit unseres Systems basiert auf speziell entwickelten Greifern mit Nuten, die auf 95 % der auf dem Markt befindlichen Autos passen.

3



4. CLEVERE GREIFER

Die Winkel β und γ wurden sorgfältig berechnet, so dass der Greifer perfekt auf verschiedene Radmutter ausgerichtet ist.

4

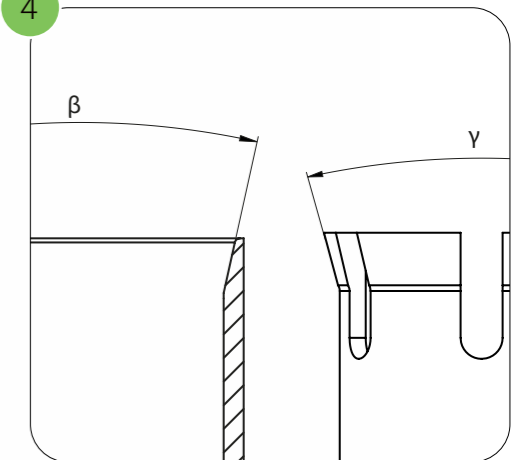

5. EINZELNER BEFESTIGUNGSPUNKT

Die Kette kann durch Klemmen an nur einer Radmutter am Rad befestigt werden, ohne dass weitere Anbauteile erforderlich sind. Die beigefügten Distanzbolzen ermöglichen die Einstellung und Montage auch auf Felgen mit sehr positiven oder negativen Einpresstiefen (ET).

5



MODELLE TABELLE



CODE	A09 - A17	S11 - S17	U49 - U55	V10-V110	TC-T6-T29	TP-T20-T29
MODELL	TRACTIVA AUTO	TRACTIVA SPORT	TRACTIVA SUV	TRACTIVA VAN	TRACTIVA CARGO	TRACTIVA PRO
EMPFOHLEN FÜR						
FREIGABE NACH EN 16662-1	0/16	0/12	0/16	0/16	0/22	0/22
MAXIMALE FREIGABE VON DER INNEREN REIFENSEITENWAND	0	0	0	0	0	0
MAXIMALE FREIGABE VOM DER LAUFFLÄCHE	16	12	16	16	22	22
AUTOMATISCHE SPANNUNG	✓	✓	✓	✓	✓	✓
AUTOMATISCHE MONTAGE	✓	✓	✓	✓	✓	✓
MONTAGEFREUNDLICHKEIT	10 ★★★★★	10 ★★★★★	10 ★★★★★	10 ★★★★★	10 ★★★★★	10 ★★★★★
HAFTUNG	10 ★★★★★	9 ★★★★★	9 ★★★★★	9 ★★★★★	10 ★★★★★	10 ★★★★★
FAHRKOMFORT	9 ★★★★★	10 ★★★★★	9 ★★★★★	9 ★★★★★	9 ★★★★★	10 ★★★★★

TRACTIVA AUTO



Mit einer Gliederhöhe von 16 mm ist die Tractiva Auto die stärkste und haltbarste Kette im Tractiva-Sortiment.

- Homologiert nach EN 16662-1 und ONV5117.
- Innovative Netzkonstruktion der Lauffläche.
- Einsatzgehärtete Kettenteile mit Gummispannern und speziellen Querleisten für bessere Haftung.
- Polyurethan-Führungen mit Spikes aus Wolframkarbid.
- Das clevere Tractiva-Befestigungssystem.
- Schraubensatz und Gebrauchsanweisung.
- Nylontasche und Kartonverpackung.

DIMENSIONEN

	D [mm]	4
	H [mm]	16

VERPACKUNG



TRACTIVA SPORT



Mit einer Gliederhöhe von nur 10 mm ist die Tractiva Sport die leichteste und kompakteste Kette im Tractiva-Programm.

- Homologiert nach EN 16662-1 und ONV5117.
- Innovative Netzkonstruktion der Lauffläche.
- Einsatzgehärtete Kettenteile mit Gummispannern und speziellen Querleisten für bessere Haftung.
- Polyurethan-Führungen mit Spikes aus Wolframkarbid.
- Das clevere Tractiva-Befestigungssystem.
- Schraubensatz und Gebrauchsanweisung.
- Nylontasche und Kartonverpackung.

DIMENSIONEN

	D [mm]	3
	H [mm]	10

VERPACKUNG



TRACTIVA SUV



Mit einer Gliederhöhe von 16 mm ist die Tractiva SUV für die extremsten Bedingungen gebaut. Zudem geben die D-Profil Glieder Ihrem SUV zusätzlichen Grip auf Schnee und Eis.

- Homologiert nach EN 16662-1 und ONV5117.
- Innovative Netzkonstruktion der Lauffläche.
- Einsatzgehärtete Kettenteile mit Gummispannern und speziellen Querleisten für bessere Haftung.
- Polyurethan-Führungen mit Spikes aus Wolframkarbid.
- Das clevere Tractiva-Befestigungssystem.
- Schraubensatz und Gebrauchsanweisung.
- Nylontasche und Kartonverpackung.

DIMENSIONEN

	D [mm]	4
	H [mm]	16

VERPACKUNG



ERSATZTEILE

ZERLEGTE ANSICHT

AUTO, SPORT & SUV

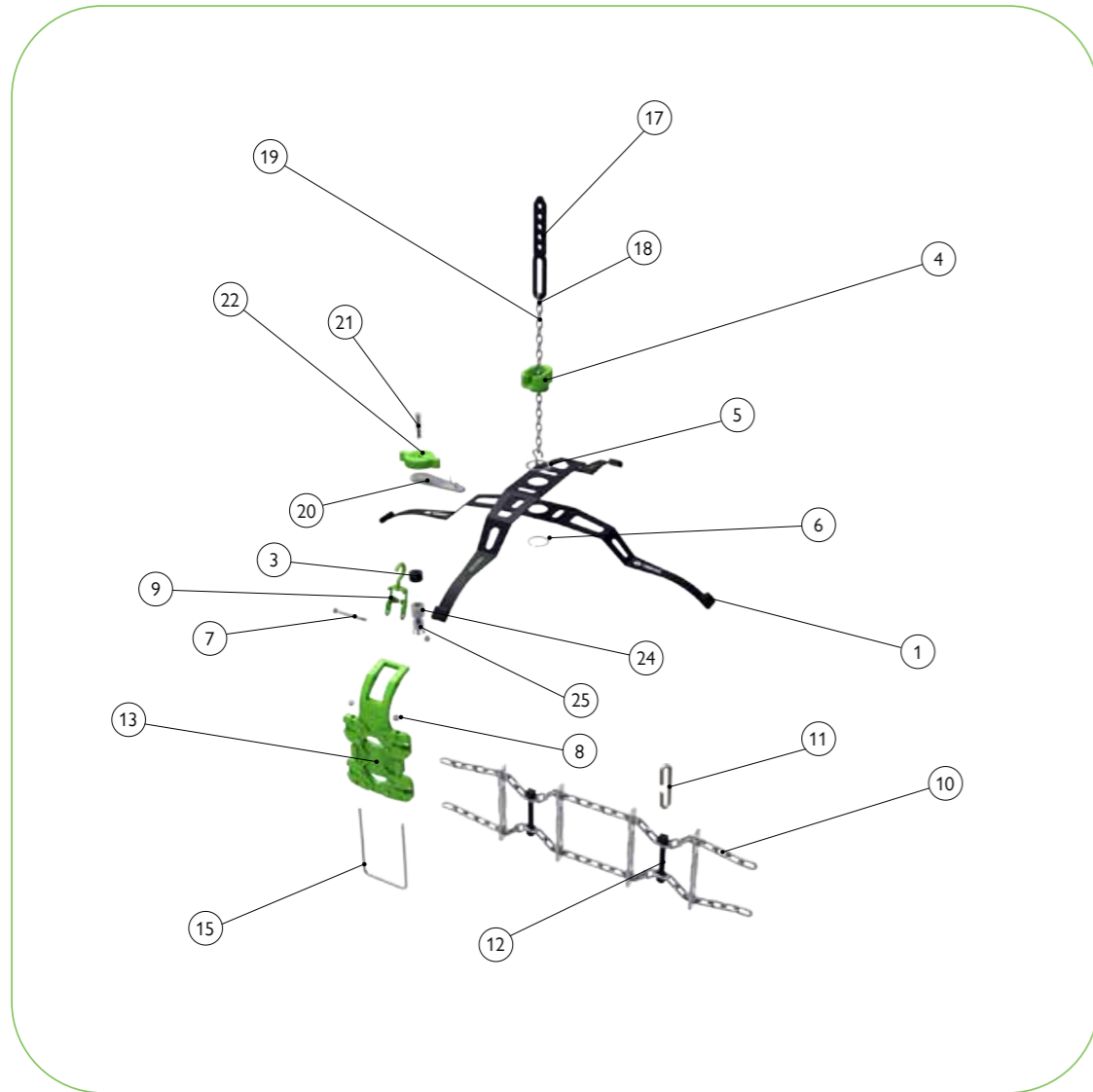

ERSATZTEILE













ZUSAMMENFASSUNG

Ersatzteile	Codes	Beschreibung	Ersatzteile	Codes	Beschreibung
1	47895 RT-A10 47896 RT-A20 47897 RT-A30 47898 RT-A40 47899 RT-A50 47900 RT-A60 47901 RT-A70	Tractiva Metallarm für Auto- und Sport-Modell	6	43828 (100 00 003)	Sicherungsring für Metallarme
2	47902 RT-U10 47903 RT-U20 47904 RT-U30 47905 RT-U40 47906 RT-U50 47907 RT-U60	Tractiva Metallarm für SUV-Modell	7	43829 M5X50	Verbindungsschrauben M5 × 50
3	43825 DCTS	Mittelkappe aus Nylonharz für SUV-Modell	8	a. 43830 (M5 MATICA) b. 43831 (M3,5 MATICA)	a. Verzinkte Mutter M5 b. Verzinkte Mutter M3,5
4	43826 ZCT	Mittelkettenanschlag aus Nylonharz	9	43832 KNVT	Metallischer Kettenhaken
5	a. 43846 DDT b. 43847 DKT	a. Distanzbolzen – lang b. Distanzbolzen – kurz	10	a. 43918-43 43873-40 43871-42 43874-39 43872-41 43875-38 b. 43619-32 43880-28 43877-31 43881-27 43878-30 43882-26 43879-29	Kettensegment für: a. Sport-Modell Kettensegment für: b. Auto- und SUV-Modell









ERSATZTEILE

ZUSAMMENFASSUNG

Ersatzteile	Codes	Beschreibung	Ersatzteile	Codes	Beschreibung
11 	43834 CST	Querglied zur Verkürzung	16 	43857 SNT	Komplettes Tractiva-Befestigungssystem
12 a.  b. 	a. 43835 GTS b. 43836 GTAS	a. Gummispanner für Auto- und SUV-Modell b. Gummispanner für Sport-Modell	17 	43839 GNT	Gummispanner für Tractiva-System
13 a.  b. 	a. 43837 EVTAS b. 43838 EVTS	a. Polyurethan-Führungen für Auto- und SUV-Modell b. Polyurethan-Führungen für Sport-Modell	18 	43840 COT	Ersatzglied für Spannkette
14 a.  b. 	a. 26982 b. 43885	a. Splint 6 x 30 mm b. Kettenglied Verbindungsbolzen	19 	43841 VNT	Tractiva Spannkette mit Haken
15 	43886	Stahlhalterung für Sport-Modell	20 	43842 PCT	Tractiva-System Metallhebel

ERSATZTEILE

ZUSAMMENFASSUNG

Ersatzteile	Codes	Beschreibung	Ersatzteile	Codes	Beschreibung
21 a.  b. 	a. 43843 M8x60 b. 43844 M8x95	a. Schraube M8 x 60 b. Schraube M8 x 95	24 	a. 43851 D-17-T b. 43852 D-19-T c. 43853 D-21-T d. 44209 D-22-T	a. 17 mm Greiferzange b. 19 mm Greiferzange c. 21 mm Greiferzange d. 22 mm Greiferzange
22 	43845 KMT	Tractiva Drehknopf	25 	a. 43854 V-17-T b. 43855 V-19-T c. 43856 V-21-T d. 44210 V-22-T	a. 17 mm Greifer b. 19 mm Greifer c. 21 mm Greifer d. 22 mm Greifer
23 	a. 43848 O-17-T b. 43849 O-19-T c. 43850 O-21-T d. 44208 O-22-T	a. 17 mm Greifergehäuse b. 19 mm Greifergehäuse c. 21 mm Greifergehäuse d. 22 mm Greifergehäuse	26 	49126	Greifer universal

TRACTIVA AUTO & SPORT

DIMENSIONSPROGRAMM

N° KETTE	13' - 14'	15'	16'	17'	18'	19'	20'	21' - 24'	
AUTO TA 10 SPORT TS 10	175/80-13 S1 235/60-13 S1 255/55-13 S1 165/80-14 S4 175/75-14 S3 185/70-14 S2 195/65-14 S1 205/65-14 S4 215/60-14 S2	165/70-15 S1 175/65-15 S1 185/60-15 185/65-15 S4 195/60-15 S2 205/55-15 215/55-15 S3 215/45-16 225/50-15 235/50-15 S2 255/45-15 S1 265/45-15 S4 285/40-15 S1 345/35-15 S4	175/60-16 S2 185/55-16 S1 195/55-16 S4 205/50-16 S1 215/45-16 225/40-17 S1 235/40-17 S4 245/35-17 255/45-16 S1 265/40-16 S3 275/35-17 S4	175/55-17 S4 185/50-17 S3 195/45-17 205/45-17 S2 215/40-17 225/40-17 S1 235/40-17 S4 245/35-17 255/35-18 S4 265/30-18 275/35-17 S4	205/40-18 S4 215/35-18 225/35-18 S2 235/35-18 S4 245/30-18 255/30-18 S1 265/30-18 S2	225/30-19 S3 235/30-19 S4	275/20-20 S3		
AUTO TA20 SPORT TS20	185/80-13 195/80-13 S4 165/80-14 S4 175/75-14 S3 185/70-14 S2 195/65-14 S1 215/65-14 S2 225/60-14 235/60-14 S2	155/80-15 185/70-15 S3 195/65-15 S2 205/60-15 215/60-15 S3 225/55-15 235/55-15 S3 245/50-15 265/50-15 S4 275/45-15	185/60-16 205/55-16 S1 225/50-16 S1 235/50-16 S3 245/45-16 255/45-16 S2 275/40-16	205/50-17 S2 215/45-17 225/45-17 S1 245/40-17 255/40-17 S2 285/30-18 295/30-18 S1	205/45-18 S4 215/40-18 225/40-18 S2 245/35-18 255/35-18 S2 285/30-18 295/30-18 S1	215/35-19 S1 225/35-19 S3 245/30-19 255/30-19 S2 265/30-19 S4 305/25-19 S2 315/25-19 S3	225/30-20 S4 275/25-20 S4		
AUTO TA30	195/75-13	165/80-15 175/75-15 175/80-15 S4 185/75-15 S4 205/65-15 S1 215/55-16 215/65-15 S4 225/60-15 S2 270/50-15 S2 275/50-15 S3	165/75-16 S3 175/70-16 S2 185/65-16 S1 195/60-16 205/60-16 S2 215/55-16 225/55-16 S3 245/50-16 S2 250/50-16 S3 255/50-16 S4	175/65-17 S4 185/60-17 S3 195/55-17 205/55-17 S3 215/50-17 S1 225/50-17 S3 235/45-17 245/45-17 S2 255/45-17 S4 265/40-17 275/40-17 S2 285/40-17 S4 315/35-17 S2	175/55-18 S2 195/50-18 S2 215/45-18 S2 225/45-18 S4 235/40-18 245/40-18 S2 255/40-18 S4 265/35-18 275/35-18 S2 285/35-18 S3 315/30-18 335/30-18 S4	235/35-19 S1 245/35-19 S3 275/30-19 S1 285/30-19 S3 295/30-19 S4 335/25-19 S2 355/25-19 S4	235/30-20 S1 245/30-20 S3 255/30-20 S4 285/25-20 S2 295/25-20 S3		
AUTO TA40 SPORT TS40	195/80-14 S2 265/60-14 S4	195/70-15 195/75-15 S4 225/65-15 S4 235/60-15 S1 245/60-15 S4 285/50-15 S2	175/75-16 195/65-16 215/60-16 S1 220/60-16 S3 225/60-16 S4 235/55-16 S2 245/55-16 S2 265/50-16 S3	185/65-17 S3 195/60-17 S2 215/55-17 S2 235/50-17 S2 265/45-17 S3 295/40-17 S2 335/35-17 S2	195/55-18 S3 205/50-18 S1 215/50-18 S3 235/45-18 S3 265/40-18 S3 295/35-18 S1	225/40-19 S1 235/40-19 S3 255/35-19 305/25-20 315/25-20 S2 325/25-20 S3	225/35-20 S2 265/30-20 S2 305/25-20 315/25-20 S2 325/25-20 S3	235/30-21 S4 275/25-21 S3	
AUTO TA50 SPORT TS50	205/80-14 S4 215/75-14 S3	185/80-15 S3 205/70-15 275/55-15 S4 295/50-15 S2	195/70-16 S3 205/65-16 S2	205/60-17 S3 225/55-17 S3 245/50-17 S3 275/45-17 S3	205/55-18 S4 225/50-18 S4 245/45-18 S3 275/40-18 S3 315/35-18 S3	195/50-19 S3 245/40-19 S3 275/35-19 S2 285/35-19 S4 325/30-19 S3 335/30-19 S4	225/40-20 S3 235/35-20 S2 245/35-20 S3 275/30-20 S2 285/30-20 S3 335/25-20 S2 345/25-20 S4	245/30-21 S3 295/25-21 S4 375/20-21 S4	
AUTO TA60 SPORT TS60	215/80-14 S1	195/80-15 S4 205/75-15 S3 215/70-15 S2 235/65-15 S3 255/60-15 S3 305/50-15 S2	175/80-16 S2 205/70-16 S4 255/55-16 S3	185/70-17 S4 255/50-17 S3	195/60-18 S4 255/45-18 S3 285/40-18 S2 295/40-18 S4	175/60-19 S4 205/50-19 S3 225/45-19 S2 255/40-19 S3 295/35-19 S3 345/30-19 S4	155/60-20 S4 265/35-20 S4	255/30-21 S2 265/30-21 S4 255/25-22 S2	
AUTO TA70 SPORT TS70		205/80-15 S4 215/75-15 S2 225/70-15 235/70-15 S4 245/65-15 S1 275/60-15 S4	185/75-16 195/75-16 S1 215/65-16 215/70-16 S3 225/65-16 S1 235/60-16 245/60-16 S1 275/55-16 S4 295/50-16 S2	205/65-17 S1 215/60-17 215/65-17 S4 225/60-17 S2 235/55-17 245/55-17 S2 275/50-17 S3	215/55-18 225/55-18 S3 235/50-18 245/50-18 S2 250/50-18 S2 265/45-18 275/45-18 S3 345/35-18 S1	155/70-19 S1 195/55-19 205/55-19 S3 215/50-19 S1 225/50-19 S3 235/45-19 245/45-19 S2 265/40-19 275/40-19 S2 285/40-19 S4 305/35-19 325/35-19 S4	175/55-20 195/50-20 S2 215/45-20 S2 225/45-20 S4 245/40-20 S2 255/40-20 S4 275/35-20 S2 285/35-20 S3 295/30-20 305/30-20 315/30-20 S1 325/30-20 S2 335/30-20 S4	245/35-21 S3 255/35-21 S4 275/30-21 S1 285/30-21 S2 295/30-21 S4 325/25-21 345/25-21 S3 355/25-21 S4 235/30-22 S1 245/30-22 S3 255/30-22 S4 275/25-22 285/25-22 S2 295/25-22 S3 305/25-22 S4	

An der Kette befinden sich 4 Verkürzungen.
S1-S4 = Anzahl der Verkürzungen, die bei Bedarf entfernt werden können.

TRACTIVA 4x4 SUV & VAN

DIMENSIONSPROGRAMM

N° KETTE	14' - 15'	16'	17'	18'	19'	20	21' - 24'	N° KETTE	14' - 19'
SUV TU10	255/70-14 265/70-14 S4 225/75-15 S2 235/70-15 S4 245/70-15 S3 255/65-15 265/65-15 S4	195/80-16 S2 195/85-16 S4 205/75-16 S1 225/70-16 S2 235/60-16 235/65-16 245/65-16 S4 255/60-16 265/60-16 S3	205/70-17 S2 215/65-17 S4 225/65-17 S3 235/60-17 S1 245/60-17 S4 255/55-17 265/55-17 S3 315/45-17 S1	215/60-18 S1 235/55-18 S1 245/55-18 S4 255/50-18 265/50-18 S3 285/45-18 S1 295/45-18 S3	205/55-19 S3 215/55-19 S2 235/50-19 S2 255/45-19 265/45-19 S2 295/40-19 S2 345/35-19 S3	195/55-20 S3 235/45-20 S2 245/45-20 S4 255/40-20 S4 265/40-20 S2 285/35-20 S3 295/35-20 S1 305/35-20 S3 345/30-20 S1	265/35-21 S2 275/35-21 S4 305/30-21 S1 315/30-21 S3 265/30-22 S2 275/30-22 S3 315/25-22 S1 335/25-22 S4	VAN TV10	175/70-14 185/60-15 195/60-15 S2 195/55-16 S4
SUV TU20	215/80-15 S1 235/75-15 S4	215/75-16 235/70-16 S4 275/60-16 S4	215/70-17 S3 235/65-17 S4 275/55-17 S4	225/60-18 S2 235/60-18 255/55-18 S4 275/50-18 S3	245/50-19 S2 255/50-19 S4 275/45-19 S2 285/45-19	275/40-20 S2 285/40-20 S4 315/35-20 S2 325/35-20 S4	245/40-21 S2 255/40-21 S4 285/35-21 S3 325/30-21 S2 245/35-22 S2 255/35-22 S4 285/30-22 S2 295/30-22 S4 305/25-23 S4	VAN TV20	185/65-15 S4 195/65-15 S2 205/55-16 195/60-16 205/50-17 S2
SUV TU30	225/80-15 S1 255/70-15 265/70-15 S4 275/65-15	205/80-16 205/85-16 S4 215/80-16 S3 225/75-16 S2 225/80-16 S4 245/70-16 S3 255/65-16 265/65-16 S3 285/60-16 S3	195/80-17 S2 205/75-17 245/65-17 S3 255/60-17 265/60-17 S3	225/65-18 S3 245/60-18 S3 265/55-18 S3 285/50-18 S1	225/55-19 S2 235/55-19 S1 245/55-19 S4 265/50-19 S3 295/45-19 S3	235/50-20 S1 245/50-20 S4 295/40-20 S2 305/40-20 S4	195/55-21 S3 235/45-21 S2 245/45-21 S4 265/40-21 S2 295/35-21 S1 315/35-21 S4 345/30-21 S1 265/35-22 S2 275/35-22 S3 305/30-22 S1 315/30-22 S3 275/30-23 S3 315/25-23 S1 275/25-24 S2 285/25-24 S4	VAN TV30	195/70-15 205/60-16 S2 215/55-16 215/50-17 S1
SUV TU40	245/75-15 255/75-15 S4 275/70-15	235/75-16 S3 255/70-16 S4 275/65-16 S4	225/70-17 235/70-17 S3 255/65-17 S4 275/60-17 S4	235/65 18 S4 255/60 18 S4	235/60-19 S4 255/55-19 S4 275/50-19 S2	195/65-20 S4 255/45-20 265/45-20 275/45-20 S2	305/35-21 255/40-22 S4 285/35-22 S2 295/30-23 S3 255/30-24 S4	VAN TV40	215/65-15 S4 195/65-16 215/60-16 S1 205/55-17 S3 215/55-17 S2 225/45-18 S4
SUV TU50	265/75-15 S3 275/75-15 S3 325/60-15 S1	245/75-16 S2 215/85-16 S1 235/80-16 S4 265/70-16 S2 285/65-16 S2	225/75-17 235/75-17 S4 245/70-17 S2 265/65-17 S2 285/60-17 S2	225/70 18 S1 265/60 18 S2 285/55 18 S1	265/55-19 S2 275/55-19 S4 285/50-19	235/55 20 0 265/50 20 S1 285/45 20 295/45 20 S2	235/50-21 255/45-21 S4 265/45-21 S1 275/40-21 S1 285/40-21 265/40-22 S1 295/35-22 305/35-22 S1 315/35-22 S3 285/35-23 S4 305/30-23 315/30-23 S1 325/30-23 S3 275/30-24 S2 285/30-24 S4	VAN TV50	215/70-15 S2 205/65-16 S2 225/55-17 S3 245/45-18 S3
SUV TU60	245/85-15 S4 32X11.5 15	225/85-16 S2 255/75-16 S2 275/70-16 S2 280/70-16 S4	245/75-17 S4 255/70-17 S2 265/70-17 275/65-17 S2	255/65-18 S2 275/60-18 S1 285/60-18 S4	235/65-19 S2 255/60-19 S2 285/55-19 S4	235/60-20 S2 255/55-20 S2 275/50-20 275/55-20 285/50-20 S3 305/45-20	255/50-21 S2 275/45-21 285/45-21 S2 295/40-21 315/40-21 S4 255/45-22 S2 275/40-22 275/45-22 285/40-22 S1 295/40-22 S4 325/35-22 S1 265/40-23 S4 285/40-23 295/35-23 S2 305/35-23 S4 315/30-24 S4	VAN TV60	235/55-17 215/60-17 255/45-18 S3
								VAN TV70	225/70-15 195/75-16 S1 215/65-16 225/65-16 S1 245/45-19 S2
								VAN TV80	205/75-16 S1 235/65-16
								VAN TV90	215/75-16
								VAN TV100	225/75-16 S2
								VAN TV110	255/65-17 S4 255/60-18 S4
								VAN TV120	245/75-16 S2

An der Kette befinden sich 4 Verkürzungen.
S1-S4 = Anzahl der Verkürzungen, die bei Bedarf entfernt werden können.

TRACTIVA VAN



Diese Kette mit Schnellmontage, automatischer Spannung und ohne Klemmung an der Rückseite ist die richtige Wahl für alle, die mit dem Wohnmobil auf Winterreise gehen. Sie ist außerdem für alle Lieferfahrzeuge geeignet, da sie mit 16 mm D-Gliedern eine bessere Traktion und höhere Stabilität auf verschneiten und vereisten Straßen bietet.

- Zugelassen nach EN 16662-1 und ONV5117.
- Innovative Netzstruktur der Lauffläche.
- Zementierte Kettenteile mit Gummispannelementen und speziellen Querprofilen für bessere Traktion.
- Ein System aus 4 Hebeln und Karbonspitzen aus Stahl auf 4 Polyurethanführungen.
- Eine spezielle, patentierte Spannmethode.

Verpackung: 1 Paar in einer Nylontasche und Kartonverpackung.

DIMENSIONEN

	D [mm]	4
	H [mm]	16

VERPACKUNG

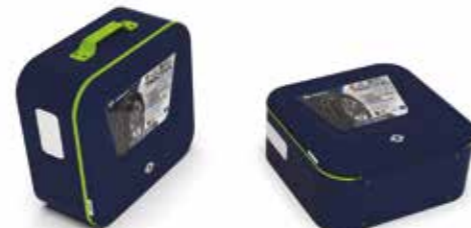

TRACTIVA CARGO



Kette für Frachtfahrzeuge mit schnellem Zusammenbau. Ausgestattet mit einem D-Profil Kettenglied von 6 mm, ist Tractiva CARGO eine Lösung mit schnellster Montage für alle Lastkraftwagen. Sie wird außerhalb des Reifens angebracht und umfasst eine vierarmige Anordnung, sowie Spikes aus Kohlenstoffstahl auf 4 Kunststoffführungen. Tractiva Cargo ist eine Notfall- und Langzeitkette.

- Gemäß ON V5119 geprüft;
- Innovative, patentierte Einhaklösung.
- Einsatzgehärtete Kette mit Metallgriffleisten und Verkürzungsschrauben zur Regulierung.
- Polyurethan-Führungen mit Spikes aus Kohlenstoffstahl.
- Die Betriebsanleitung ermöglicht einen schnellen Zusammenbau.

Verpackung: Nylontasche für jede Paarhälfte.

DIMENSIONEN

	D [mm]	6
	H [mm]	22

TRACTIVA PRO



Ausgestattet mit einem D-Profil Kettenglied von 6 mm, ist Tractiva Pro die professionelle Lösung mit maximaler Haftung, aufgrund der sechsarmigen Anordnung, sowie Spikes aus Hartmetall auf 6 Kunststoffführungen. Geeignet für Fahrer mit engem Terminplan, für internationale Strecken, sowie für jede Gelegenheit, bei der die schnelle Montage und Demontage ein Muss ist.

- Gemäß ON V5119 geprüft.
- Innovative, patentierte Einhaklösung.
- Einsatzgehärtete Kette mit Metallgriffleisten und Verkürzungsschrauben zur Regulierung.
- Polyurethan-Führungen mit Spikes aus Kohlenstoffstahl.
- Die Betriebsanleitung ermöglicht einen schnellen Zusammenbau.

Verpackung: Nylontasche für jede Paarhälfte.

DIMENSIONEN

	D [mm]	6
	H [mm]	22

TRACTIVA

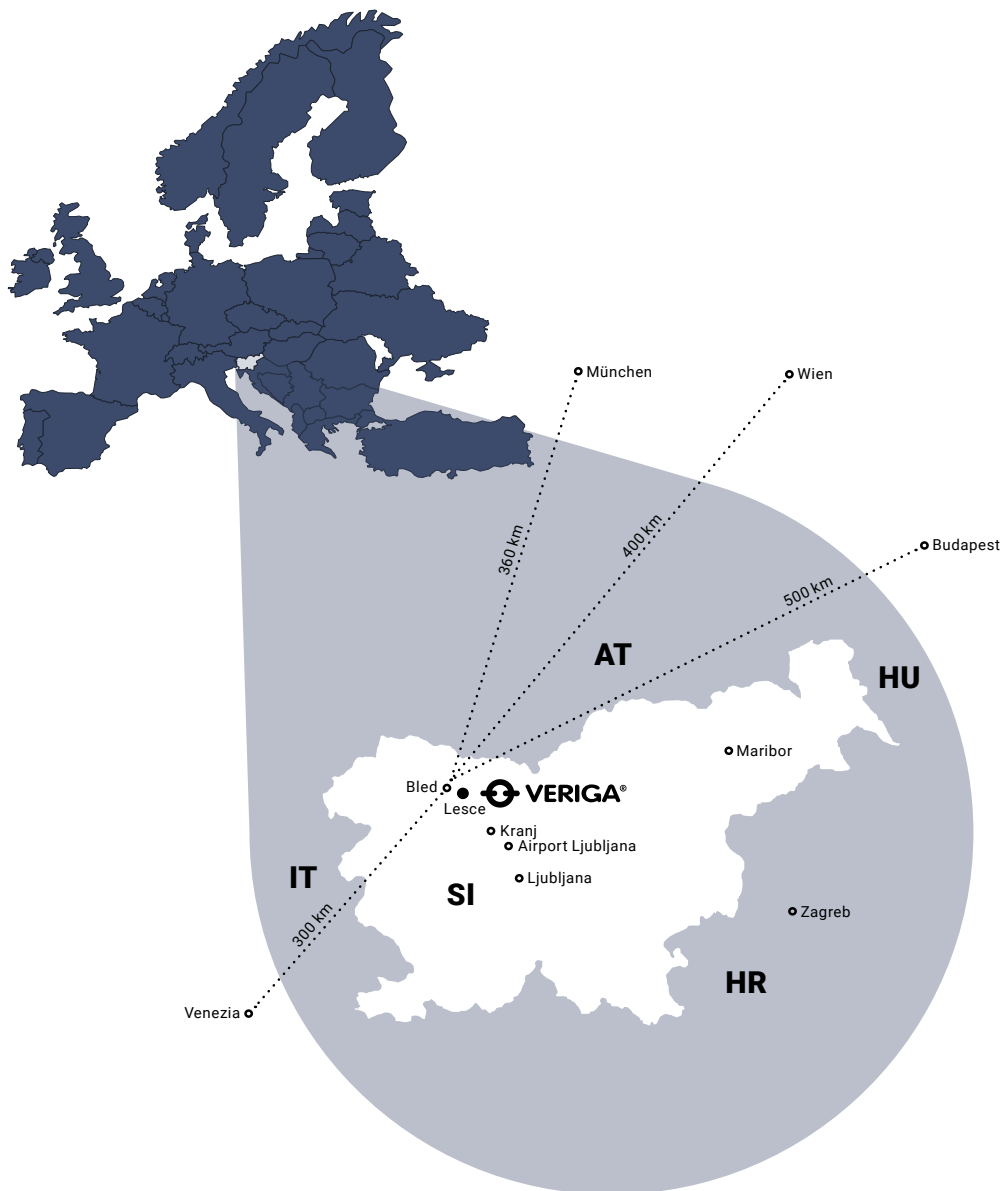

VERIGA K.F., d.o.o.

Alpska cesta 43
SI - 4248 Lesce
Slovenia, EU

T.: +386 (0)4 537 09 00
E.: info@veriga-lesce.com
W.: www.veriga-lesce.com

Sledite nam / Follow us / Folgen Sie uns



VerigaLesce



veriga_lesce



veriga



2026